

INSTRUCTIONS
FOR USE

A-dec 532/533

DELIVERY SYSTEMS



 a-dec®

Copyright

© 2021 A-dec, Inc. All rights reserved.

A-dec Inc. makes no warranty of any kind with regard to this material, including, but not limited to, the implied warranties of merchantability and fitness for a particular purpose. A-dec Inc. shall not be held liable for any errors contained herein or any consequential or other damages concerning the furnishing, performance or use of this material. The information in this document is subject to change without notice. If you find any problems in the documentation, please report them to us in writing. A-dec Inc. does not warrant that this document is error-free.

No part of this document may be copied, reproduced, altered, or transmitted in any form or by any means, electronic or mechanical, including photocopying, recording, or by any information storage and retrieval system, without prior written permission from A-dec Inc.

Trademarks and Additional Intellectual Property Rights

A-dec, the A-dec logo, A-dec Inspire, Cascade, Century Plus, Continental, Decade, ICX, ICV, Performer, Preference, Preference Collection, Preference ICC, Radius, and reliablecreativesolutions are trademarks of A-dec Inc. and are registered in the United States and other countries. A-dec 500, A-dec 400, A-dec 300, A-dec 200, and EasyFlex are also trademarks of A-dec Inc. None of the trademarks or trade names in this document may be reproduced, copied, or manipulated in any manner without the express, written approval of the trademark owner.

Certain touchpad symbols and icons are proprietary to A-dec Inc. Any use of these symbols or icons, in whole or in part, without the express written consent of A-dec Inc., is strictly prohibited.

Acteon, Satelec, and SP Newtron are registered trademarks of Financiere Acteon SAS. Color Coding System is also a trademark of Financiere Acteon SAS. All other trademarks cited herein are the property of their respective owners.

Regulatory Information and Warranty

For required regulatory information and the A-dec warranty, see the *Regulatory Information, Specifications, and Warranty* document (p/n 86.0221.00) available in the Resource Center at www.a-dec.com.

Product Service

Product service is available through your local authorized A-dec dealer. To locate an authorized dealer, or for additional service information, visit www.a-dec.com or contact A-dec at 1.800.547.1883 in the USA and Canada or 1.503.538.7478 worldwide.

Product Models and Versions Covered in This Document

Model	Version	Description
532/533	B	Delivery System

Content Map

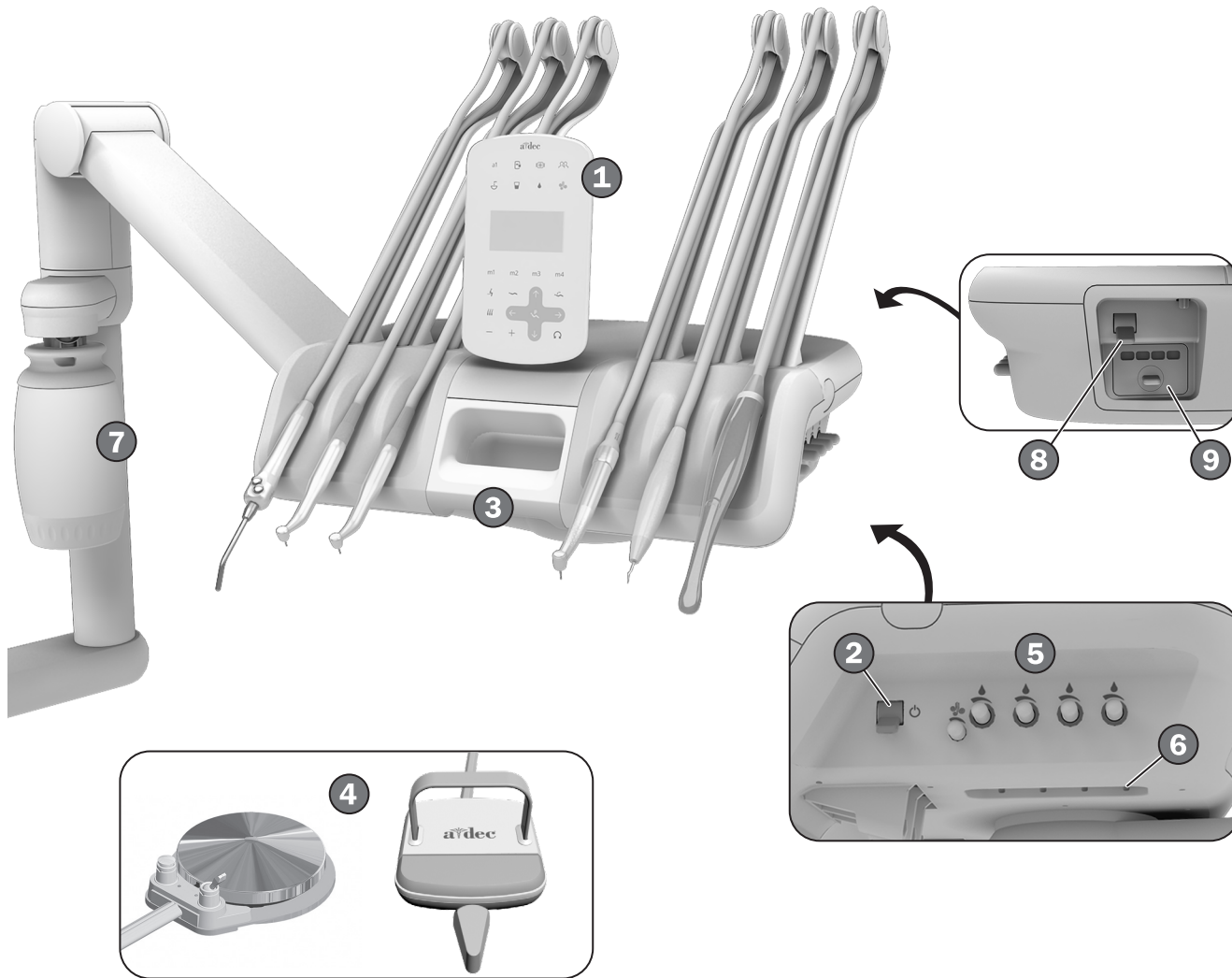

Features/Topics

1	Touchpad Content Map	3
2	Master Toggle	4
3	Positive Positioning System	6
4	Foot Control	7
5	Handpiece Coolant	21
6	Handpiece Drive Air	23
7	Self-Contained Water Bottle/ Waterline Maintenance	27
8	Handpiece Tubing Flush	28
9	Oil Collector	28
	Utilities	30
	Specifications	31

Deluxe Plus Touchpad Content Map



Icon	Function	Page
a1	Auxiliary Device	8
	Touchpad Lockout	8
	Dental Light	11
	A/B User	8
	Cuspidor Bowl Rinse and Cupfill	12
	Water and Air Coolant On/Off	13
m1 – m4	Instrument Memory Presets	14
	Chair Manual Controls	9
	Chair Presets	10
	Program Mode.....	10
	Handpiece Mode	16
– +	Decrease/Increase/Selection Controls	16
	Motor Forward/Reverse	15

Note: Touchpad icons and symbols are proprietary to A-dec Inc.

Operate / Adjust

Turn On/Turn Off the Air, Water, and Power

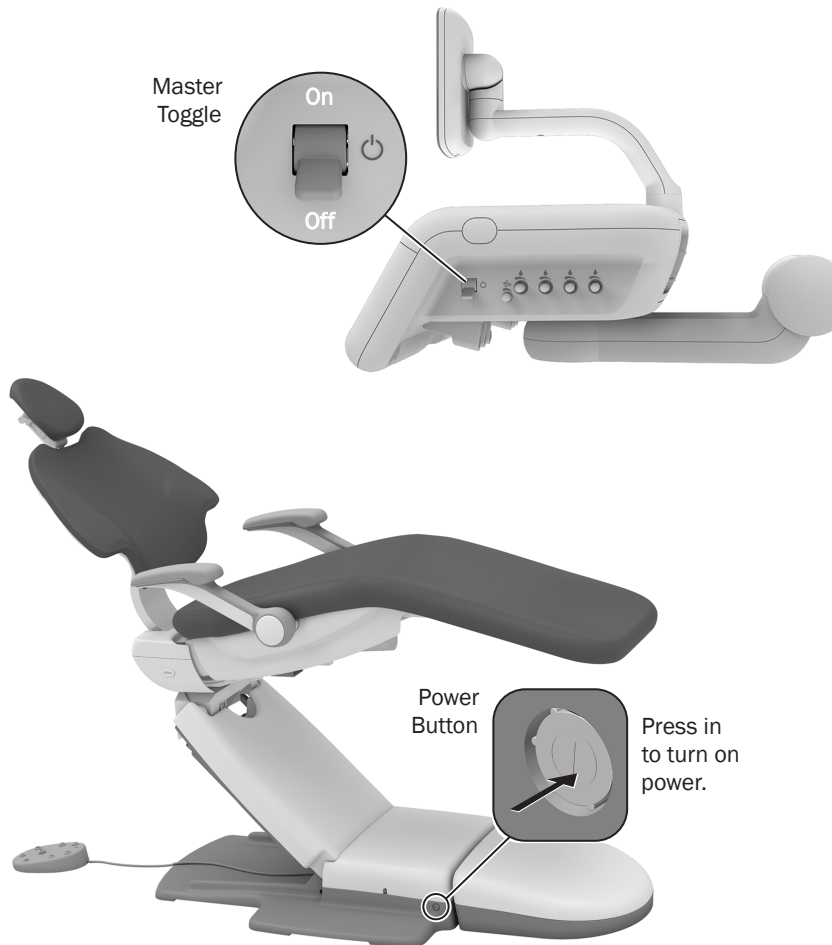

NOTE A-dec recommends that you perform a shock treatment on the dental unit waterlines before you use the system for the first time. For more information, see “Waterline Maintenance” on page 28.

Master Toggle

Use the master toggle to turn on the system air, water, and power. If there is no power to the system, verify that the power button on the chair is pressed in. This button must be on in order for the master toggle to control system power.

When to Turn Off the Power

To save energy and reduce the chance of air leaks, press the power button to turn off power at the end of the day and before longer periods of non-use.

Chair Safety Features



A-dec dental chairs and systems include safety features (like the chair stop plate) that may stop or prevent the chair from moving. This may occur due to any of the following:

- There's an obstruction under the chair or attached module.
- The foot control disc or lever is pressed.
- A handpiece isn't properly seated in its holder.

If the Chair Stops Unexpectedly or Won't Move

Check for and correct any of the conditions listed above. If an obstruction is blocking chair movement, use the touchpad or footswitch to raise the chair, then remove the obstruction.

Operate the Autoclavable Syringe

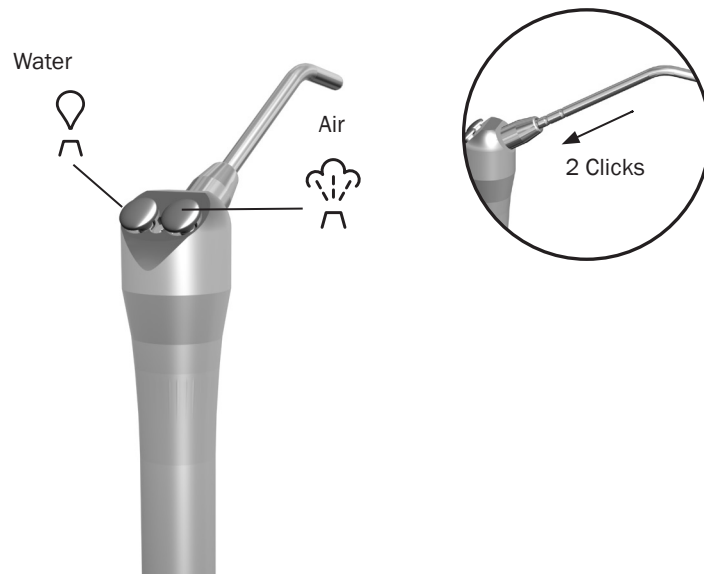

To install the A-dec syringe tip, push the tip in until you feel two clicks. Press both buttons simultaneously for the air/water spray.



IMPORTANT For more details on syringe usage and maintenance, see your A-dec syringe Instructions for Use.

Position the Delivery System

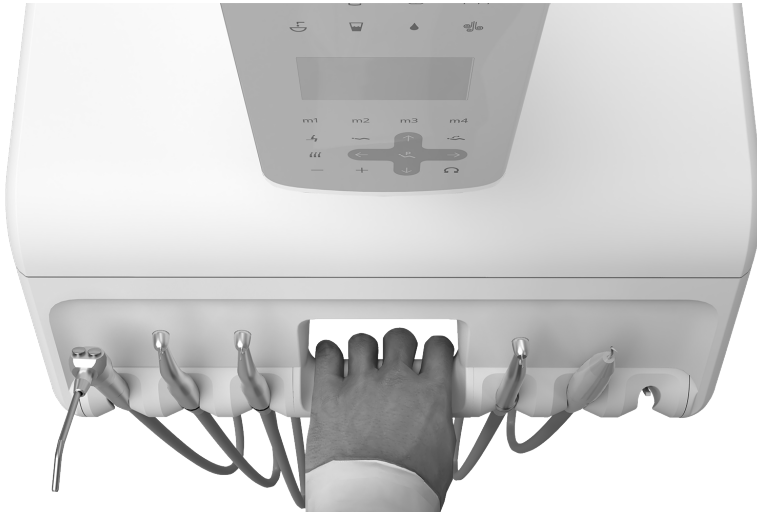

NOTE You can place up to 4 pounds (1.8 kg) on top of the system or optional tray holder.

The positive positioning system holds the delivery system in place until you grasp the handle. A sensor detects your grip and releases the brake. To position the system:

1. Grasp the handle.
2. Move the system to the desired location.
3. Release the handle to re-engage the brake.

Position the Handpiece Holders

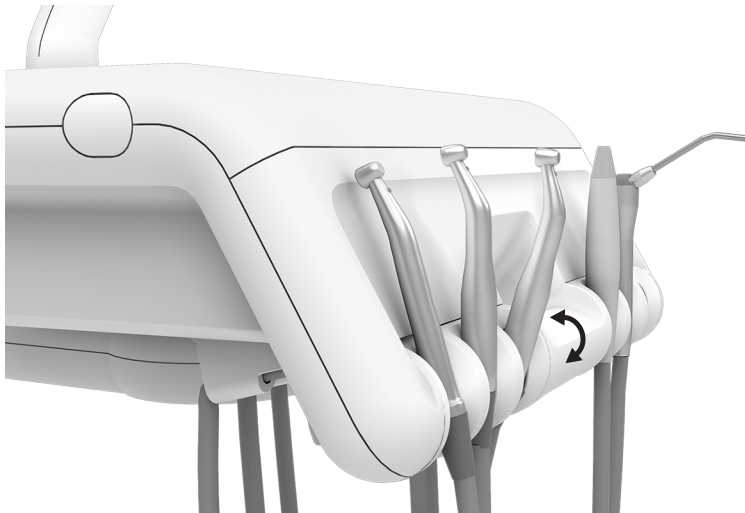

CAUTION Do not use a handpiece or other clinical device to adjust the holder or you may damage that device.

On 532 Traditional delivery systems, you can independently adjust each handpiece holder. Use your hand (or A-dec syringe as leverage) to adjust the holder until you achieve the desired angle.

Operate the Foot Control

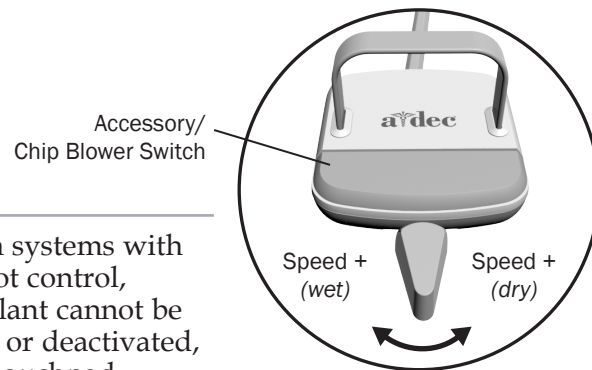
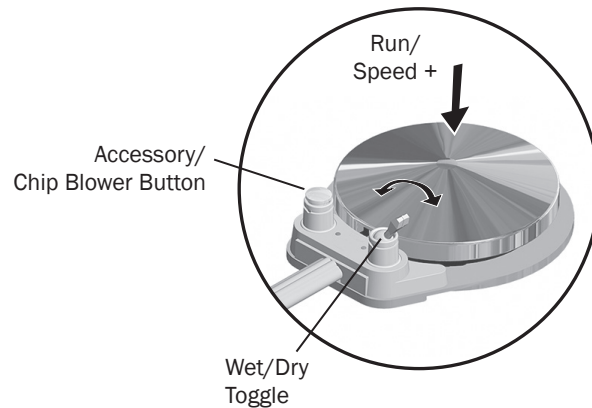

NOTE On systems with a lever foot control, water coolant cannot be activated, or deactivated, from the touchpad.



NOTE The lever foot control wet/dry function can be reversed by a technician (change left direction to dry, right direction to wet). For more details, contact your authorized A-dec dealer.





To activate a handpiece, lift it from the holder or pull the whip forward. Use the foot control to perform the desired handpiece operation.

Control	Operation	Procedure
Disc Foot Control	Run a handpiece.	Press on the disc. Push down to increase speed.
	Run a handpiece with or without water coolant.	Press  on the touchpad to turn the coolant on or off, or flip the wet/dry toggle (which works as a three-way switch in conjunction with the touchpad). Then press on the disc.
	Run the optional accessory/chip blower.	Press the accessory/chip blower button.*
	Operate the intraoral camera.	Press on the disc to capture an image.*
Lever Foot Control	Run a handpiece with water coolant.	Move the lever to the left. Move farther to increase speed.
	Run a handpiece without water coolant.	Move the lever to the right. Move farther to increase speed.
	Run the optional accessory or chip blower.	Press the accessory/chip blower switch.*
	Operate the intraoral camera.	Move the lever to the left or right to capture an image.*

* Contact your authorized A-dec dealer for questions about the operation or configuration of your integrated A-dec sanctioned clinical devices.

Operate Touchpad Lockout, User Setting, and Auxiliary Device Control



Icon/Function	Actions/Options
 Touchpad Lockout	Press and hold  to activate the touchpad lockout, which allows you to barrier protect and clean/disinfect the touchpad without unintentionally activating any commands. A small light above the icon flashes while the touchpad is locked for 15 seconds.
 A/B User	Two sets of customizable settings (A and B) are available. To select a different user setting, press  . The selected user setting is indicated by the A or B in the lower left corner of the touchpad display.
a1 Auxiliary Device On/Off	If your system includes an A-dec relay module and a connected device, press a1 to turn on or turn off that device. A small light above the icon illuminates when the device is on.
	NOTE If two operators use the delivery system, be sure to select the correct user setting (A or B) before changing any memory settings. The selected set is indicated by the A or B in the lower-left corner of the touchpad display.

Position the Chair with Manual Controls

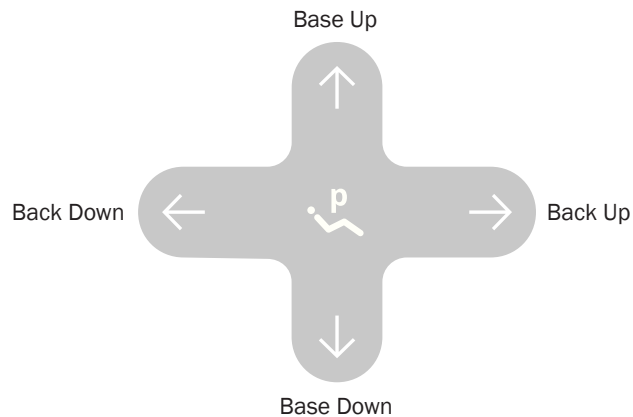
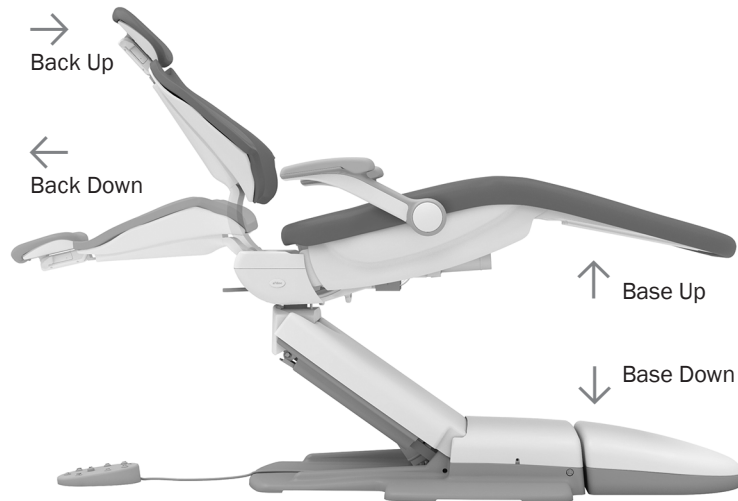

IMPORTANT The A-dec touchpad and footswitch move the chair in the same manner. For more details about footswitch controls, see your chair Instructions for Use.



WARNING Ensure that the patient is positioned safely before using the manual or preset chair controls. Never leave the patient unattended while the chair is in motion. Always take extra care with small children and patients with limited mobility.

To stop the chair at any point during preset movement, press any chair positioning button on the footswitch or touchpad.



NOTE If you would like to adjust the maximum height of your chair, contact your local authorized A-dec dealer.

Icon/Function	Actions/Options
↑ Base Up	Press and hold ↑ to raise the chair base.
↓ Base Down	Press and hold ↓ to lower the chair base.
→ Back Up	Press and hold → to raise the chair back.
← Back Down	Press and hold ← to lower the chair back.

Position the Chair with Preset Controls

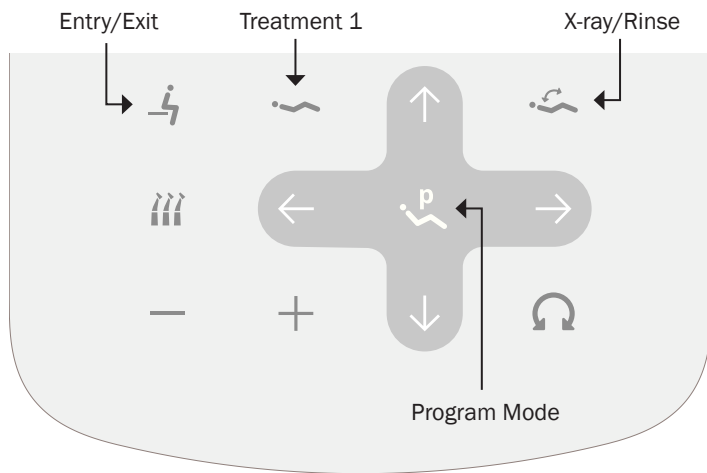

Standard Touchpad

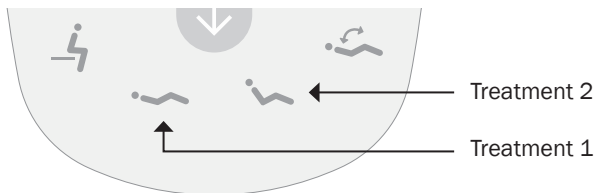

Icon	Preset Name	Factory Setting
	Entry/Exit	Positions the chair for patient entry/exit.
	Treatment 1	Positions the chair base and back down.
	Treatment 2	Positions the chair base down and the back partially up.
	X-Ray/Rinse	Moves the chair to either x-ray or rinse position. A second press moves the chair to the previous position.

Press , , or (also on the standard touchpad) to move the chair to a preset position. See the table (below left) for factory settings.

Customize the Chair Preset Positions

To customize chair presets , , and :

1. Position the chair as desired.
2. Press and hold until you hear one beep, which indicates program mode is on.
3. Within five seconds, press the chair preset you wish to change (for example, press). Three beeps confirm that your new setting is saved.

Customize the X-Ray/Rinse Chair Preset

The factory preset moves the chair and patient into an upright position for x-rays or cuspidor access. A second press of returns the chair to the previous position.

You can also set to function as a customized chair preset position. To change its function:

1. Press and at the same time and hold for three seconds.
 - One beep indicates is set as another customizable chair preset.
 - Three beeps indicate that is set as the x-ray/rinse factory preset (which toggles between the x-ray/rinse position and the previous chair position).
2. If you set as another customizable chair preset and want to assign a different chair position, follow the steps outlined above in “Customize the Chair Preset Positions.”

Operate the Cuspidor



Turn On/Turn Off Cupfill and Bowl Rinse

Use the icons on the touchpad (☪, ☵), or the buttons on the cuspidor (☵, ☵) to control cupfill and bowl rinse functions.

Icon/Function	Actions/Options
☵ (or ☵) Cupfill	<ul style="list-style-type: none"> Press once for a timed operation. The factory preset is a 2.5 second fill. Press and hold for manual operation.
☵ (or ☵) Bowl Rinse	<ul style="list-style-type: none"> Press once for a timed operation. The factory preset is a 30 second rinse. Press twice for continuous flow. Then press once to stop the flow. Press and hold for manual operation. Release to stop the flow.

Customize Cupfill and Bowl Rinse Timing on the Touchpad

1. Press and hold ☵ until you hear one beep, which indicates program mode is on.
2. Within five seconds, press and hold ☵ or ☵ for the desired time.
3. Three beeps confirm that your new settings are saved.

Customize Cupfill and Bowl Rinse Timing on the Cuspidor





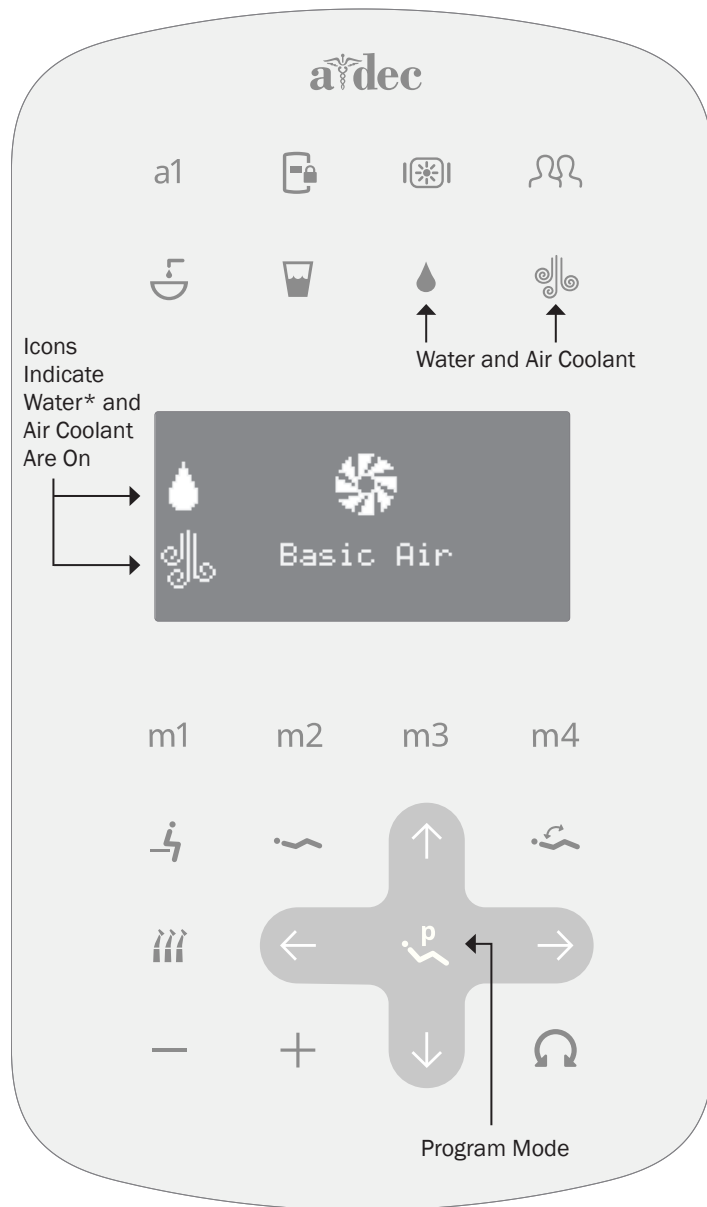





1. Press and hold ☵ and ☵ under the cupfill spout until you hear one beep, which indicates program mode is on.
2. Within five seconds, press and hold ☵ or ☵ for the desired time.
3. Three beeps confirm that your new settings are saved.



Operate Basic Handpiece Controls



Activate the Air and Water Coolant

To see and change basic air handpiece functions on the touchpad, lift the handpiece from the holder or pull the whip forward. Basic air appears on the display screen any time a standard air-driven high- or low-speed handpiece is detected.

Icon/Function	Actions/Options
 Water Coolant On/Off*	Press  . The icon appears on the left side of the screen when the water coolant is on.
 Air Coolant On/Off	Press  . The icon appears on the left side of the screen when the air coolant is on.
 +  or  Euro Mode* On/Off	<p>Euro mode allows you to turn on or turn off water and air coolant functions at the same time with one press of either icon.</p> <p>Press and hold  and  (or  and ) for three seconds. Three beeps indicate that the Euro mode is on. One beep indicates that it is off.</p>

***NOTE** The touchpad does not control water coolant on systems with a lever foot control. If you press  on the touchpad,  will appear on (or disappear from) the display screen – whether water coolant is on or off at the handpiece. Instead, use the lever (move left or right) for wet or dry handpiece operation. For this reason, Euro Mode is not available on systems with a lever foot control.



Operate Electric Handpiece Functions

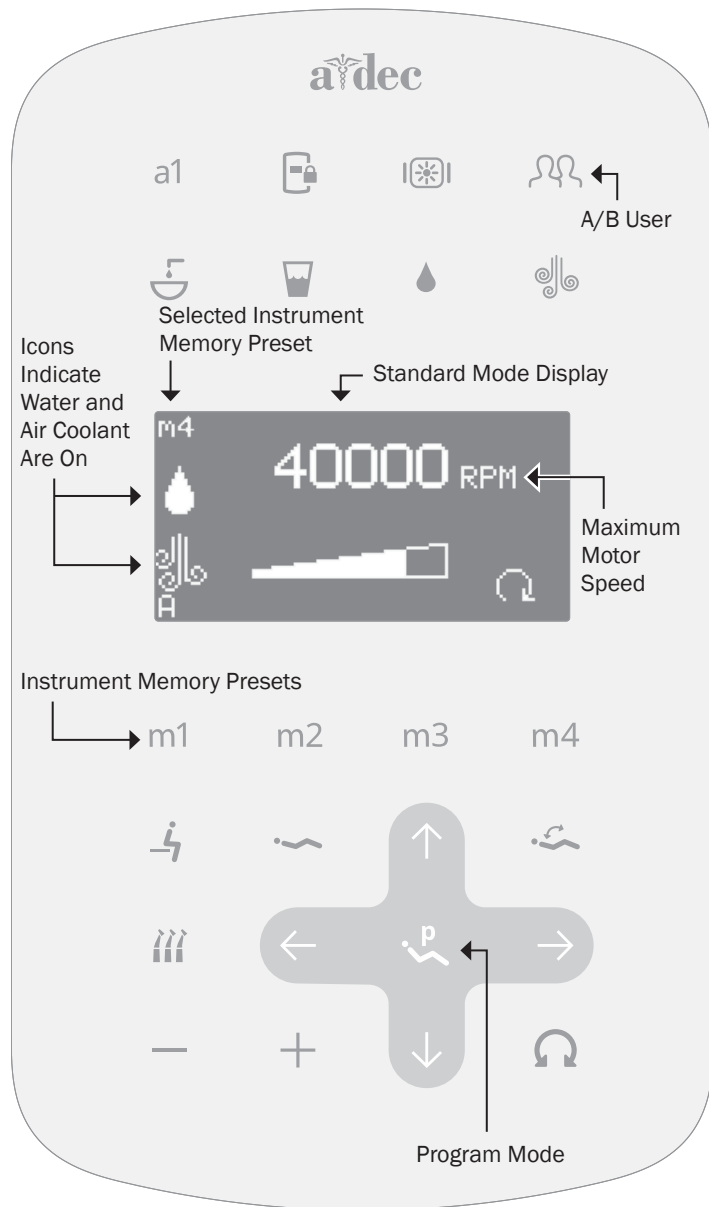

Standard Mode Memory Presets

To activate the electric handpiece, lift it from the holder or pull the whip forward. The touchpad screen displays the previous settings used for that handpiece position. Use the memory presets to control motor speed and air/water coolant. Standard mode provides four factory presets with the following values:

Memory Preset	Maximum Motor Speed	Air Coolant	Water Coolant
m1	2,000 rpm	On	On
m2	10,000 rpm	On	On
m3	20,000 rpm	On	On
m4	40,000 rpm	On	On

Customize the Standard Mode Memory Presets

You can customize the memory presets with your own specific values. In standard mode, each A/B user setting provides four memory presets for each handpiece. The endodontics mode offers an additional four presets per handpiece for each A/B user setting.

To change a preset:

1. Press $-$ or $+$ to change your preferred maximum motor speed.
2. Press 💧 and 🌀 to turn on/turn off water or air coolant.
3. Press and hold P until you hear one beep, which indicates program mode is on.
4. Within five seconds, press m1, m2, m3, or m4 to save the settings under your preferred memory preset. Three beeps confirm that your new settings are saved.

Operate Electric Handpiece Functions *(continued)*

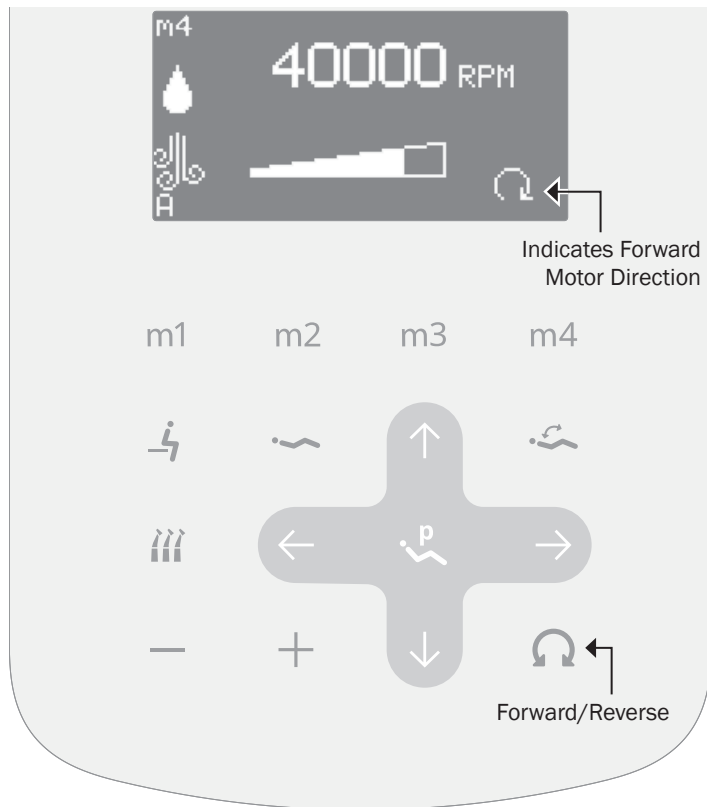

Change the Motor Direction

Press  to change the motor direction. In reverse mode, the screen icon flashes continuously. Forward/reverse cannot be saved as part of the standard mode settings. The direction defaults to forward after you return the handpiece to its holder or turn off the system.



NOTE You can also use the foot control to switch between forward and reverse. When the motor has stopped, tap the accessory/chip blower button to change the direction. For more information, see page 7.

Operate Electric Handpiece Functions *(continued)*

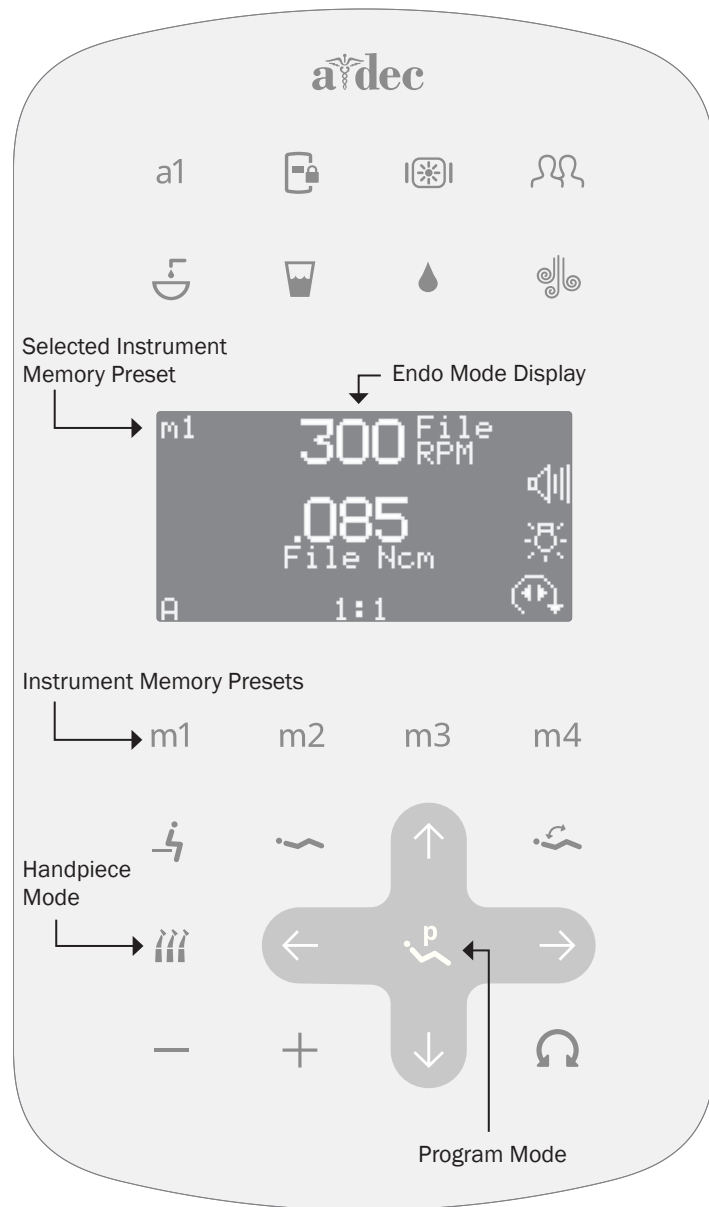



Customize the Endodontics (Endo) Mode Memory Presets

The endo mode allows you to change a number of settings based on the specific file and desired handpiece behavior. Icons on the touchpad display screen reflect the settings.



NOTE For more information regarding speed and torque limits for a specific file, consult the file manufacturer.

To customize the endo mode settings:

1. Lift the handpiece from the holder or pull the whip forward.
2. If the touchpad screen does not display the endo mode, press .
3. To change settings in endo mode, press $-$ or $+$. A white reverse video box is displayed on the touchpad screen.
4. Press \uparrow , \downarrow , \leftarrow , or \rightarrow to move from setting to setting on the touchpad screen.
5. Press $-$ or $+$ to change the setting as desired.
6. Press and hold  until you hear one beep, which indicates program mode is on.
7. Within five seconds, press m1, m2, m3, or m4 to save the settings under your preferred memory preset. Three beeps confirm that your new settings are saved.

For more details on these settings, see “Additional Details for Endo Mode Settings” on page 17.

Operate Electric Handpiece Functions *(continued)*

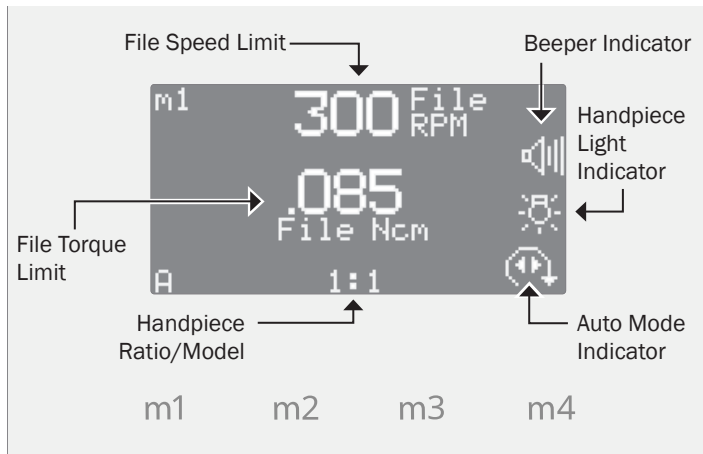

WARNING Endo file settings must be set according to the file manufacturer. File speed limits, torque limits, supported gear ratios, and supported auto modes should be provided in the endo file Instructions for Use. If these settings are not set properly, patient injury may occur. For more information, consult with your file manufacturer.

Additional Details for Endo Mode Settings

Icon	Setting	Description
	Speed	Setpoint for the file speed limit. For more information, consult your file manufacturer.
	Torque	Setpoint for the file torque limit. For more information, consult your file manufacturer.
	Torque Units	Toggles between newton centimeters (N·cm) and gram centimeters (g·cm). When you change this setting, the change applies to all endo memory presets. <i>Note: 1 N·cm = 102 g·cm.</i>
	Ratio	Indicates the handpiece ratio or handpiece model. For more information, consult your handpiece manufacturer.
	Beeper	When active, the warning beep sounds when you approach torque limit and beeps when the file auto reverses. When you change this setting, the change applies to all endo memory presets.
	Handpiece Light	Indicates if the handpiece light is on in the endo mode.
	Auto Modes	The auto mode indicator is located inside the forward/reverse indicator. When you change this setting, the change applies to all endo memory presets.
	Auto Stop	<ul style="list-style-type: none"> When the file reaches the torque limit, the motor shuts off.
	Auto Reverse	<ul style="list-style-type: none"> When the file reaches the torque limit, the motor stops and reverses direction until the foot control is released.
	Auto Forward	<ul style="list-style-type: none"> When the file reaches the torque limit, the motor stops, reverses direction, and then changes back to forward again.

Operate Electric Handpiece TF Adaptive/Reciprocating Endo Functions

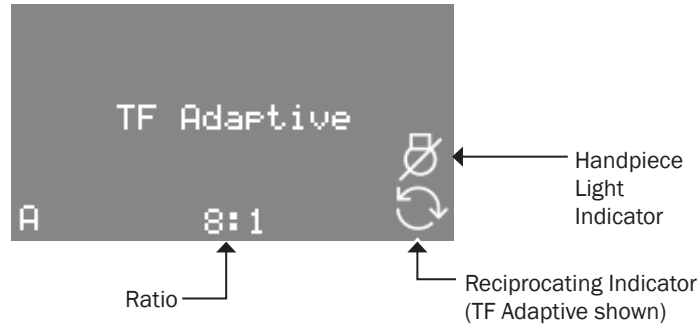

WARNING Make sure the file used in reciprocal motion is approved for a torque of 3 N-cm and a maximum speed of 600 rpm (min⁻¹).



NOTE While the file is in reciprocal motion, it initially rotates in the cutting direction, then follows a reciprocal motion in the opposite direction. Reciprocal motion takes load off the motor and prevents the file from jamming. The motion in the direction of cutting is larger than the reverse motion.



NOTE A-dec recommends use of KaVo® handpieces for the most accurate torque experience.

Reciprocating Mode Settings

Icon	Setting	Description
	Reciprocating Modes	The file rotates until it is under load. The file reciprocates until it is no longer under load when it resumes to normal rotation. The reciprocating indicator on the screen shows the mode that is in use. When you change this setting, the change applies to all reciprocating presets.
	TF Adaptive	<ul style="list-style-type: none"> This mode is for Kerr® TF™ Adaptive motion files that rotate clockwise/right. TF Adaptive mode is always set to ratio 8:1.
	File Recipro R	<ul style="list-style-type: none"> This mode is for clockwise/right rotating reciprocating files. The ratio of 8:1 is recommended. Ratios of 3:1 and 1:1 are also available.
	File Recipro L	<ul style="list-style-type: none"> This mode is for counter-clockwise/left rotating reciprocating files. The ratio of 8:1 is recommended. Ratios of 3:1 and 1:1 are also available.
	Handpiece Light	Indicates whether the handpiece light is set to be on or off in endo mode.

Kerr and TF are trademarks or registered trademarks of Kerr Corporation in the United States and may also be trademarks or registered trademarks in other countries. KaVo is a registered trademark of KaVo Dental GmbH in the United States and may also be a trademark or registered trademark in other countries.

Operate Ultrasonic Instrument Functions

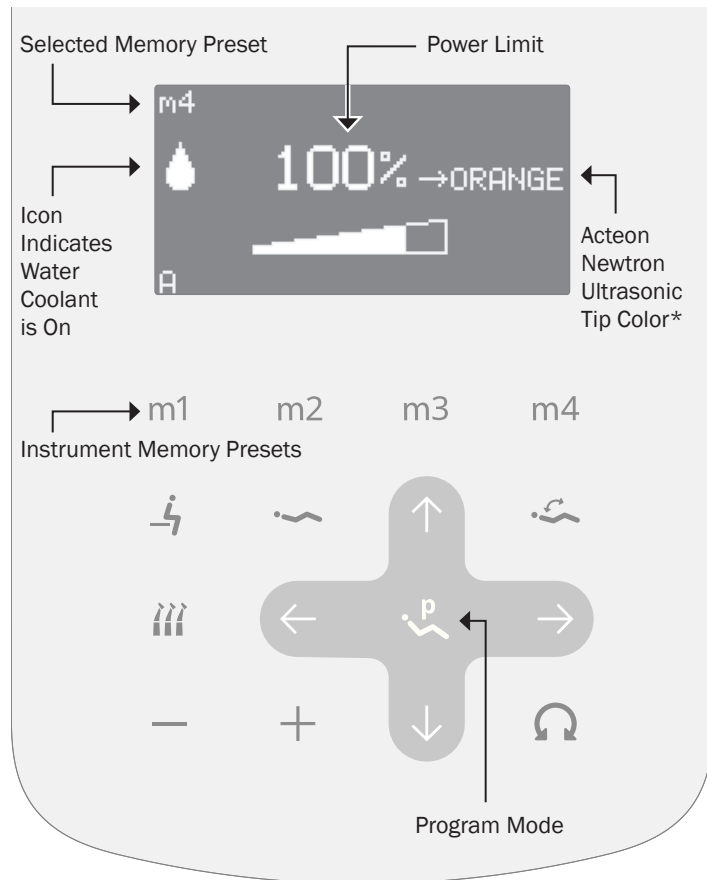

***NOTE** Tip color settings are only compatible with the Acteon Color Coding System™ and Newtron® tips. For more information, contact your local authorized A-dec dealer.



NOTE The A-dec foot control provides variable scaler output up to the maximum power limit on the display. Most tabletop devices operate differently and use on/off switching.

Ultrasonic Memory Presets

To activate the device, lift it from the holder. The previous settings used for that handpiece position appear on the display screen. Standard mode provides four factory presets with the following values:

Memory Preset	Maximum Power Limit / Acteon Tip Color*	Water Coolant
m1	25% / Green	On
m2	50% / Yellow	On
m3	75% / Blue	On
m4	100% / Orange	On

Customize the Ultrasonic Memory Presets

To customize an ultrasonic instrument preset:

1. Lift the instrument from the holder or pull the whip forward.
2. Press $-$ or $+$ to change the power limit percentage. With Acteon ultrasonic devices, the tip color changes automatically with power limit changes.
3. Press 💧 to turn on or turn off water coolant.
4. Press and hold P until you hear one beep, which indicates program mode is on.
5. Within five seconds, press m1, m2, m3, or m4 to save the settings under your preferred memory preset. Three beeps confirm that your new settings are saved.

Touchpad Help Messages

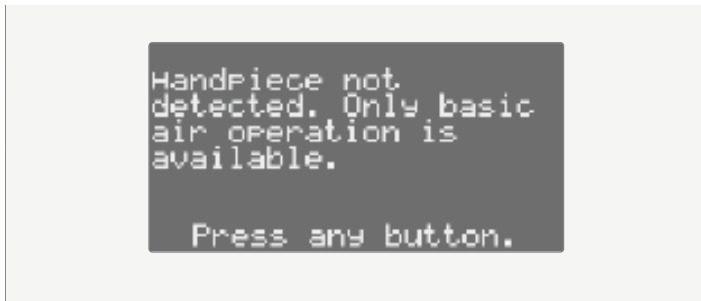

The touchpad displays help messages for disabled operations and other errors. When a help message appears, take note of the message, as well as the function you were performing, in case service is required.

For more details on help messages, see the *Regulatory Information, Specifications, and Warranty* document (p/n 86.0221.00), which is available in the Resource Center at www.a-dec.com.

Other Handpiece and Accessory Settings

Contact your authorized A-dec dealer to change any of these handpiece and accessory settings, if applicable:

- **Auto-Off Delay** - determines how long the handpiece light remains on if the foot control is released. The default setting is 5 seconds.
Note: May not be available in some versions of motors.
- **On When Selected** - specifies whether the handpiece light turns on or remains off (until the foot control is pressed) when the handpiece is removed from the holder.
- **On in Endo** - specifies whether the handpiece light turns on or off when the endo mode is selected. The default setting is off.
- **Voltage Adjustment** - allows for customized light output voltage for each handpiece position. The default setting is 3.2 VDC.

Adjust the Handpiece Coolant Spray

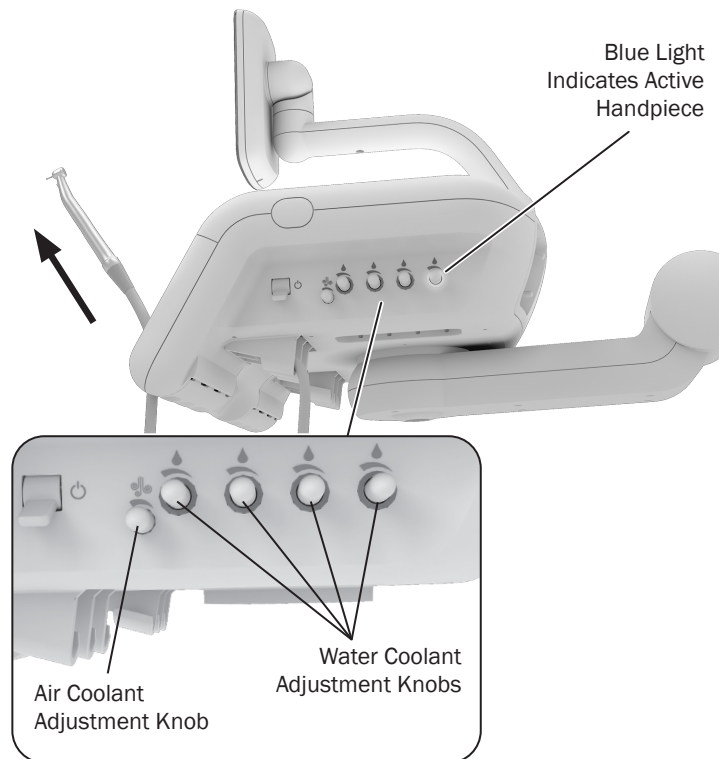

CAUTION When performing this procedure, do not attempt to completely shut off the water or air flow. The adjustment knobs are not designed to completely shut off flow and can damage the control block if you apply too much force.

The air coolant knob on your delivery system adjusts air flow to all handpiece positions simultaneously. Each water coolant knob adjusts water flow to a single handpiece position.

Use the following process to adjust for the desired handpiece coolant atomization:

1. Ensure that a bur is inserted into each handpiece you expect to adjust.
2. Lift the handpiece from the holder or pull the whip forward.
3. Press  on the touchpad to turn off the air coolant.
4. Do one of the following:
 - On systems with a disc foot control – use the touchpad or wet/dry toggle to turn on the water coolant, then press the disc all the way down.
 - On systems with a lever foot control – move the lever all the way to the left to run the handpiece at full speed with water.
5. Gently turn the water coolant adjustment knob (to the corresponding handpiece) clockwise until coolant flow stops. Then slowly turn the knob counterclockwise until water droplets are expelled from every water port on the handpiece head.
6. Release the foot control and return the handpiece to the holder.
7. Repeat steps 2 through 6 for each handpiece.

Continue with step 8 on page 22.

Adjust the Handpiece Coolant Spray *(continued)*

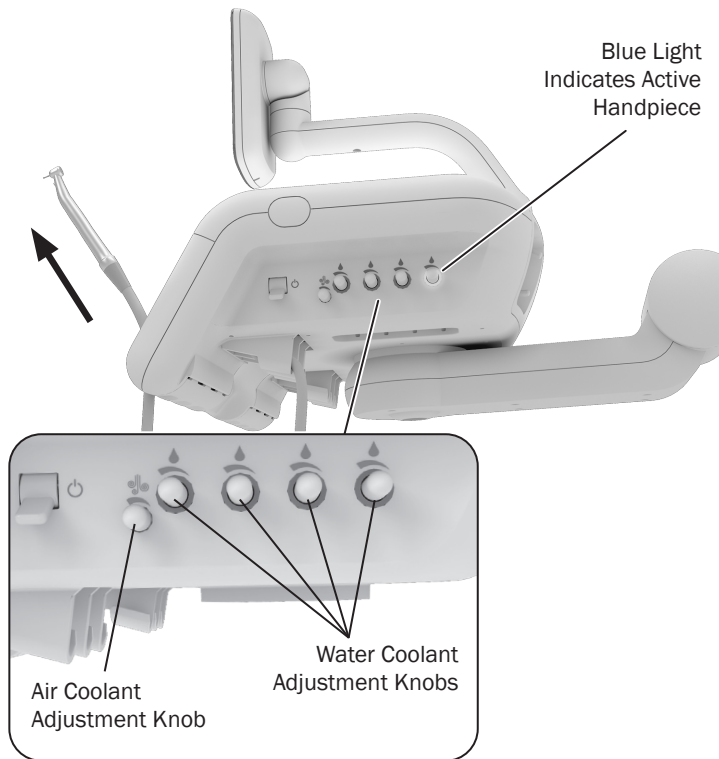

8. Lift the handpiece from the holder, or pull the whip forward, and press  on the touchpad to turn on the air coolant.
9. Fully press the foot control.
10. Locate the air coolant adjustment knob. Adjust the air coolant until you achieve the desired atomization at the cutting surface of the bur. Counterclockwise increases flow.



CAUTION Do not continue turning the air coolant adjustment knob counterclockwise after the air coolant stops increasing. The stem may come out of the control block.

11. Use the water coolant adjustment knob, as needed, to make any additional fine adjustments in water coolant output.
12. Repeat steps 8 through 11 for each handpiece.



Adjust Handpiece Drive Air Pressure

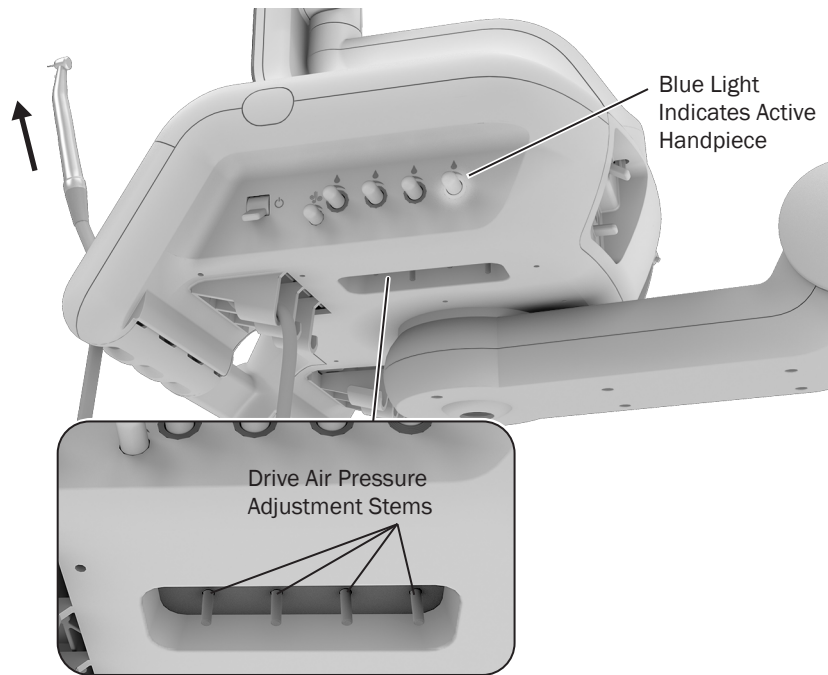

CAUTION Exceeding the manufacturer's recommended drive air pressure increases the risk of damage and may significantly decrease the life of your handpiece components. For the proper drive air pressure, see the handpiece manufacturer's Instructions for Use.



NOTE Drive air pressure varies throughout the system and can be more than 5 psi (34 kPa) lower at the handpiece than what is shown on the touchpad. To achieve the most accurate drive air measurement, use a handpiece pressure gauge attached to the handpiece tubing. To order a gauge, or for more information, contact your local authorized A-dec dealer.



TIP When you lift the handpiece, or pull the whip forward, a blue light around the water coolant adjustment knob indicates which handpiece is active. Use the light to locate the corresponding drive air adjustment stem under the delivery system.

Adjust Handpiece Drive Air Pressure *(continued)*

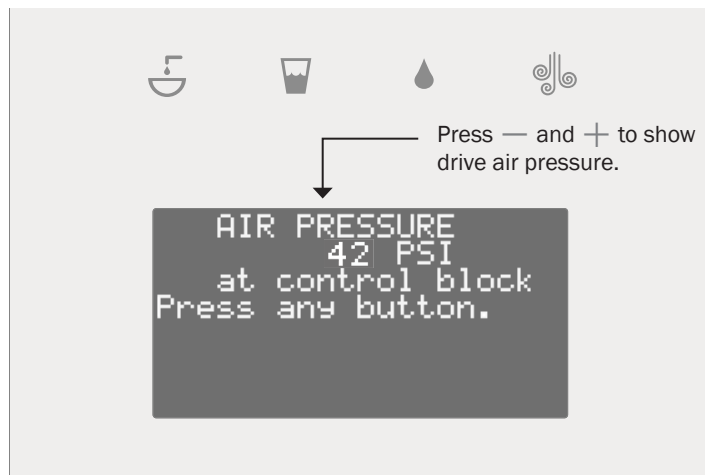
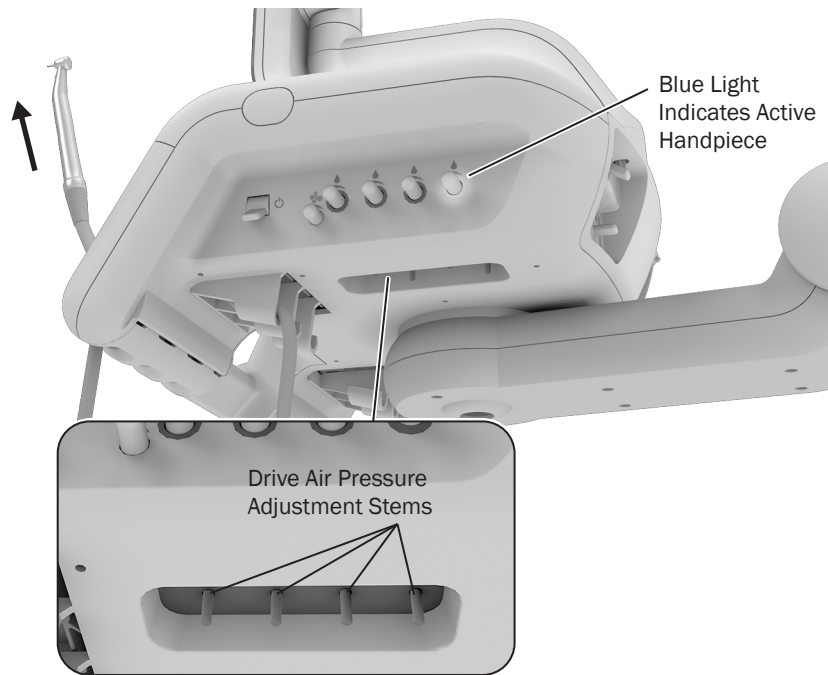

A handpiece must be attached to the tubing to read the pressure.

For systems with a **disc foot control**:

1. Lift the handpiece from the holder or pull the whip forward.
2. Use the touchpad or wet/dry toggle to turn off the water coolant.
3. Press — and + at the same time to show the drive air pressure on the touchpad.
4. Locate the drive air pressure adjustment stem, under the delivery system, that corresponds with the active handpiece.
5. Fully press the foot control to run the handpiece and adjust the drive air pressure to meet the manufacturer's specifications.

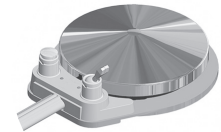

For systems with a **lever foot control**:

1. Lift the handpiece from the holder or pull the whip forward.
2. Press — and + at the same time to show the drive air pressure on the touchpad.
3. Locate the drive air pressure adjustment stem, under the delivery system, that corresponds with the active handpiece.
4. Move the foot control lever all the way to the right to run the handpiece at full speed without water.
5. Adjust the drive air pressure to meet the manufacturer's specifications.



Level the Control Head

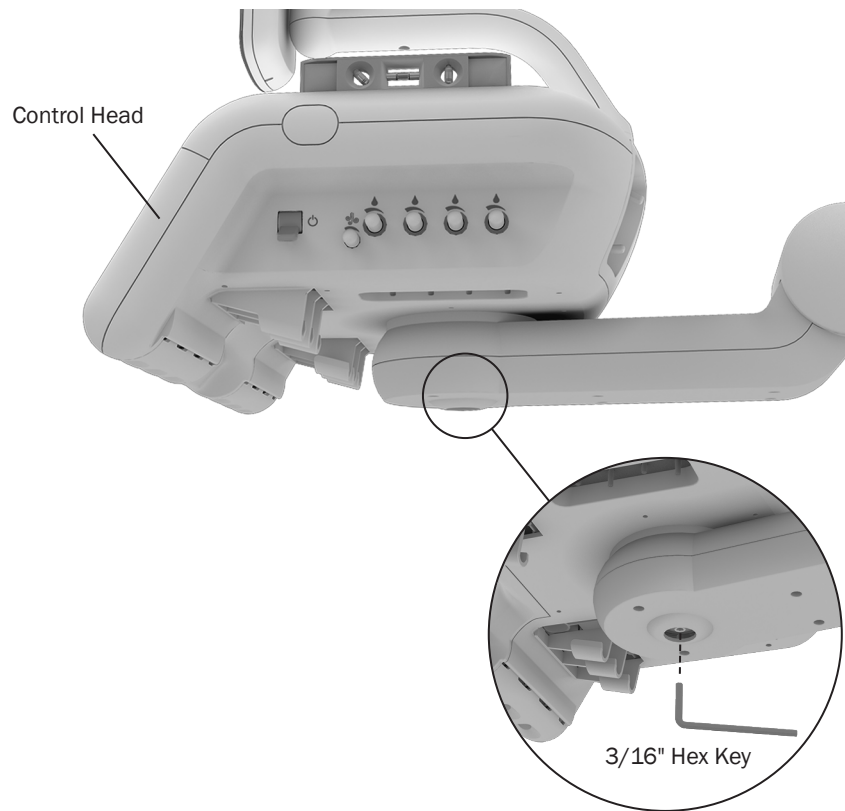

If the system is tilted front to back or side to side, level the control head.

1. Place the control head in its normal operating position, then raise the chair.
2. Place a level on top of the system.
3. Use a 3/16" hex key to loosen the adjustment screw just enough to move the control head.
4. Level the control head side to side and front to back.
5. Tighten the adjustment screw.

Adjust the Tray Holder Mount Rotation Tension

If the tray holder mount is difficult to move, or too loose, use a 7/32" hex key to adjust the rotation tension. To make the adjustment easier on the upper tray holder, hold the post while you adjust the tension screw. Clockwise increases the tension.

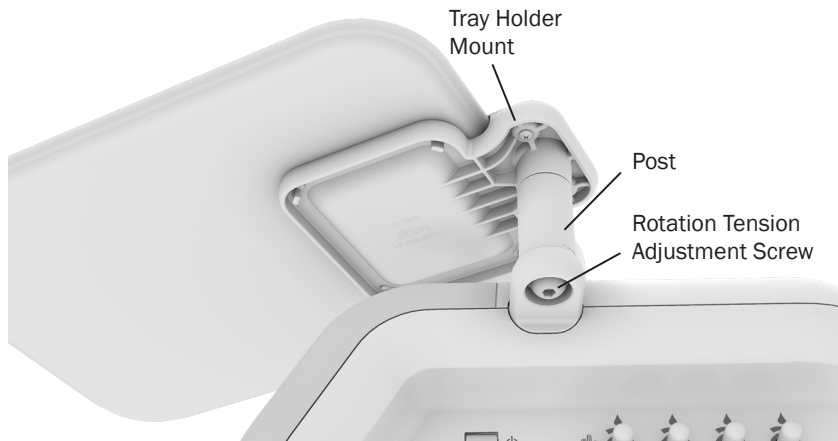

Upper Tray Holder Mount

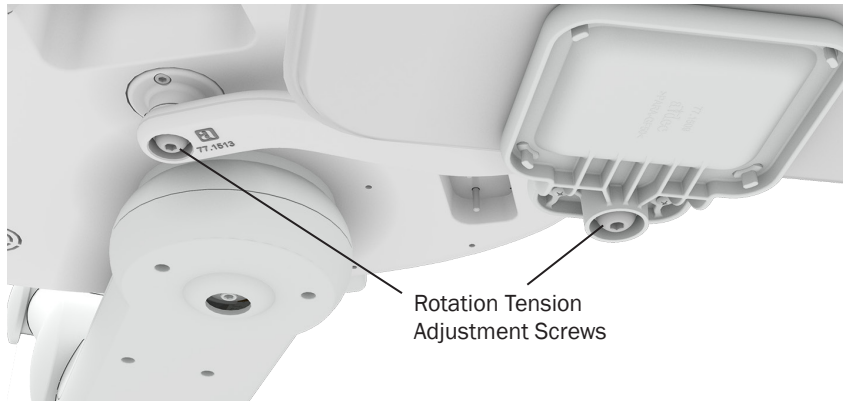

Lower Tray Holder Mount (Continental® Delivery Systems Only)

Clean / Maintain

Protect with Barriers

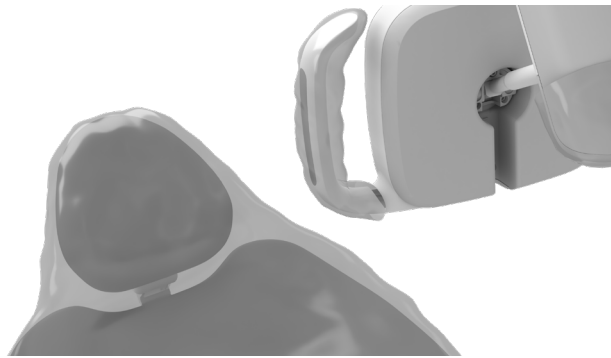

NOTE For proper use and disposal of barriers, see the barrier manufacturer's Instructions for Use.

A-dec recommends barrier protection for all applicable touch and transfer surfaces. Touch surfaces are areas that come into contact with hands and become potential cross-contamination points during dental procedures. Transfer surfaces are areas that come into contact with instruments and other inanimate objects.

In the USA, barriers must be produced under the Current Good Manufacturing Practice (CGMP) as specified by the U.S. Food and Drug Administration (USFDA). For regions outside the USA, refer to the medical device regulations specific to your location.



IMPORTANT For recommendations on cleaning and chemical disinfection of touch and transfer surfaces (where barrier protection is not applicable or when barriers are compromised), please see the *A-dec Equipment Asepsis Guide* (p/n 85.0696.00).

Waterline Maintenance



A-dec recommends that you perform a shock treatment on the dental unit waterlines before you use the system for the first time.

For on-going waterline maintenance, A-dec recommends a three-part protocol: continuous use of A-dec ICX® waterline treatment tablets, regular dental unit water monitoring, and shock treatment.



IMPORTANT For complete details on how to maintain good water quality in your system, see the Instructions for Use for ICX and your self-contained water bottle:

- A-dec ICX* p/n 86.0613.00
- A-dec Self-Contained Water System* p/n 86.0609.00
- Waterline Maintenance Guide* p/n 85.0983.00

Flush the Handpiece Tubing

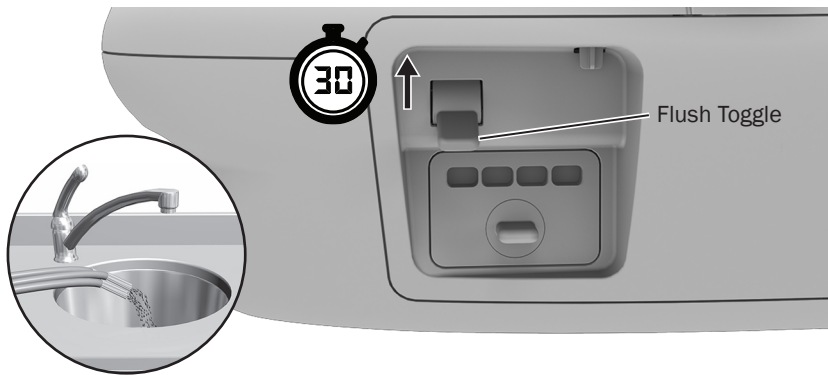

Use the flush toggle to move a high volume of water through the handpiece tubing. To flush the tubing:

1. Disconnect the handpieces.
2. Hold all of the handpiece tubing that uses water coolant over a sink, cuspidor bowl, or basin.
3. Flip the flush toggle up and hold for 20–30 seconds.



NOTE Flush all handpiece tubing (air and waterlines) in accordance with the regulations in your area. If no regulations exist, flush the tubing for a minimum of 20–30 seconds at the beginning of the day and after each patient.

Maintain the Oil Collector

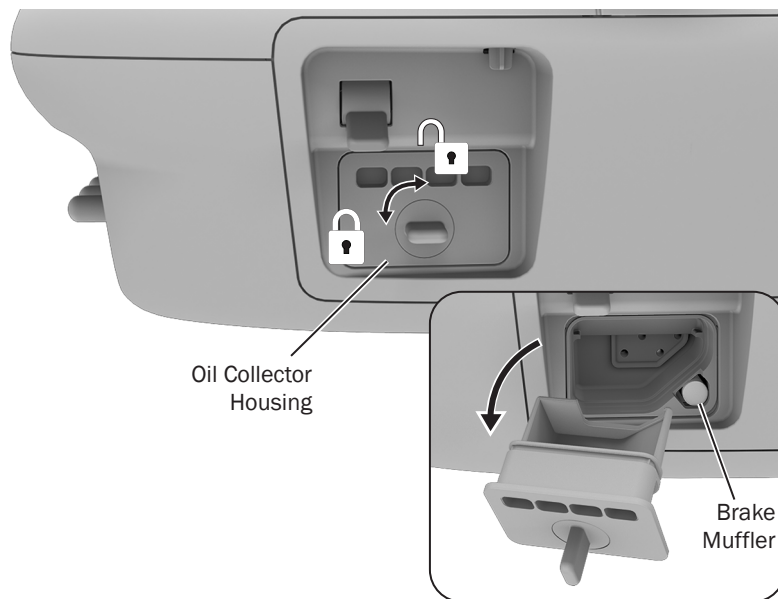

Service the oil collector on the delivery system once a week for normal use and more often for heavier use. To service:

1. Turn the oil collector housing key clockwise to unlock, then pull out the housing from the control head.



CAUTION Take care not to grab the delivery system handle while the oil collector housing is removed. The cotton roll will eject if you activate the positive positioning system.

2. Remove and replace the old cotton gauze (use two 2" x 2" [51 mm x 51 mm] pads folded in half).



NOTE Do not replace the cotton roll in the right corner of the oil collector. This is a brake muffler that will rarely need replacement. For more information, see your local authorized A-dec dealer.

3. Reinsert the housing and turn the key counterclockwise to lock.

Bulb for Fiber-Optic Tubing

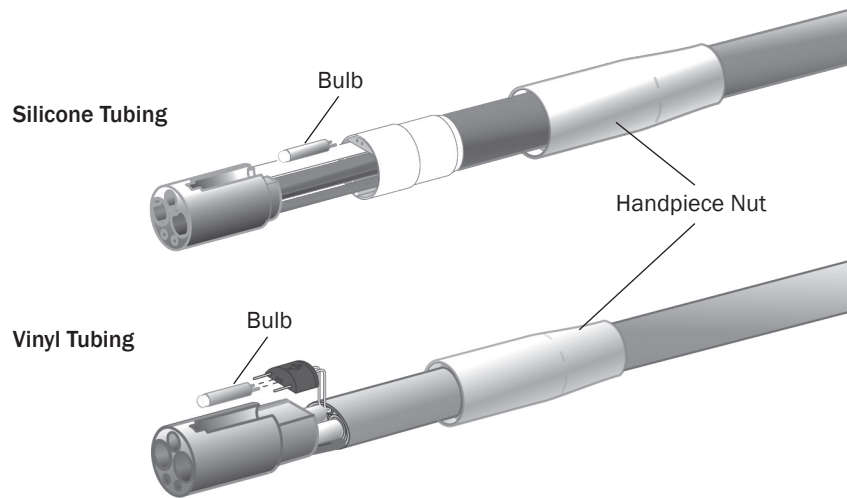

IMPORTANT To replace the bulb in your handpiece or quick-disconnect coupling, see your handpiece Instructions for Use.

To replace the bulb in your fiber-optic 5-hole silicone or vinyl tubing:

1. Disconnect the handpiece and quick-connector coupling from the tubing.
2. Pull back the metal handpiece nut.
3. Slide back the metal portion of the handpiece terminal (silicone tubing only).
4. Replace the bulb.
5. Reinsert the metal portion of the terminal into the plastic portion (silicone tubing only).
6. Carefully slide the handpiece nut back over terminal.

Access the Utilities

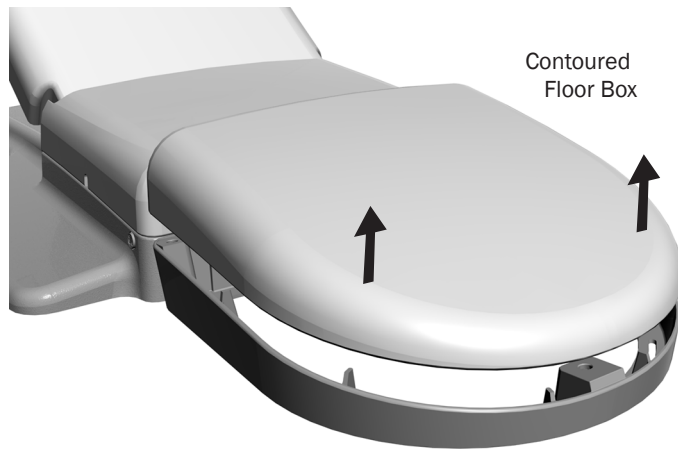

CAUTION When you remove or replace the cover, take care not to damage any wiring or tubing. Verify that the cover is secure after you replace it.

The system utilities are located in the contoured floor box under your chair and typically include the electrical outlet, as well as the system hookups for air, water, and vacuum. To access, lift the cover up and off the floor box frame. For maintenance, contact your local authorized A-dec dealer.

Specifications



System Accessory Load

Maximum accessory load capacity: 4 lb (1.8 kg)
(in addition to integrated accessories)



IMPORTANT For electrical specifications, identification of symbols, and other regulatory requirements, see the *Regulatory Information, Specifications, and Warranty* document (p/n 86.0221.00), which is available in the Resource Center at www.a-dec.com.



NOTE Specifications are subject to change without notice. Requirements may vary depending on your location. For more information, contact your authorized A-dec dealer.



 **A-dec Headquarters**

2601 Crestview Drive
Newberg, Oregon 97132
United States
Tel: 1.800.547.1883 within USA/CAN
Tel: +1.503.538.7478 outside USA/CAN
Fax: 1.503.538.0276
www.a-dec.com

A-dec Australia

Unit 8
5-9 Ricketty Street
Mascot, NSW 2020
Australia
Tel: 1.800.225.010 within AUS
Tel: +61.(0).2.8332.4000 outside AUS

A-dec China

A-dec (Hangzhou) Dental Equipment Co., Ltd.
528 Shunfeng Road
Qianjiang Economic Development Zone
Hangzhou 311100, Zhejiang, China
Tel: 400.600.5434 within China
Tel: +86.571.89026088 outside China

A-dec United Kingdom

Austin House
11 Liberty Way
Nuneaton, Warwickshire CV11 6RZ
England
Tel: 0800.ADEC.UK (2332.85) within UK
Tel: +44.(0).24.7635.0901 outside UK

CE
1434



86.0759.00 Rev D
Date of Issue 2021-06-21
Copyright 2021 A-dec, Inc.
All rights reserved.

IFUcov7