

INSTRUCTIONS
FOR USE

A-dec® 300 LED

DENTAL LIGHTS



a|dec®

Copyright

© 2024 A-dec, Inc. All rights reserved.

A-dec, Inc. makes no warranty of any kind with regard to this material, including, but not limited to, the implied warranties of merchantability and fitness for a particular purpose. A-dec, Inc. shall not be held liable for any errors contained herein or any consequential or other damages concerning the furnishing, performance or use of this material. The information in this document is subject to change without notice. If you find any problems in the documentation, please report them to us in writing. A-dec, Inc. does not warrant that this document is error-free.

No part of this document may be copied, reproduced, altered, or transmitted in any form or by any means, electronic or mechanical, including photocopying, recording, or by any information storage and retrieval system, without prior written permission from A-dec, Inc.

Intellectual Property Rights

None of the trademarks, trade names, or proprietary symbols and icons in this document may be reproduced, copied, or manipulated in any manner without the express, written approval of the trademark owner.

A-dec, A-dec+, the A-dec design logo, and the trademarks listed at [a-dec.com/legal/trademarks](https://www.a-dec.com/legal/trademarks) are A-dec trademarks or registered trademarks in the United States and other countries. Certain touch control symbols and icons are proprietary to A-dec, Inc.

In the United States, Medicom and SafeShield are trademarks or registered trademarks of AMD Medicom Inc. and may also be a trademarks or registered trademarks in other countries.

Regulatory Information and Warranty

For required regulatory information and the A-dec warranty, see the *Regulatory Information, Specifications, and Warranty* document (p/n 86.0221.00) available in the Resource Center at www.a-dec.com.



For quick access to this document online, scan, tap, or click this QR code, which points to: [a-dec.com/regulatory-guide](https://www.a-dec.com/regulatory-guide).

Product Service

Product service is available through your local authorized A-dec dealer. For service information, or to locate an authorized dealer, contact A-dec at 1.800.547.1883 in the USA and Canada or +1.503.538.7478 worldwide, or visit www.a-dec.com.

Product Models and Versions Covered in This Document*

Models	Versions	Description
371L/372L/374L 375L/376L/377L 378L	A	Dental Light

* Some products, versions, and options in this document may not be available in certain regions.

Content Map

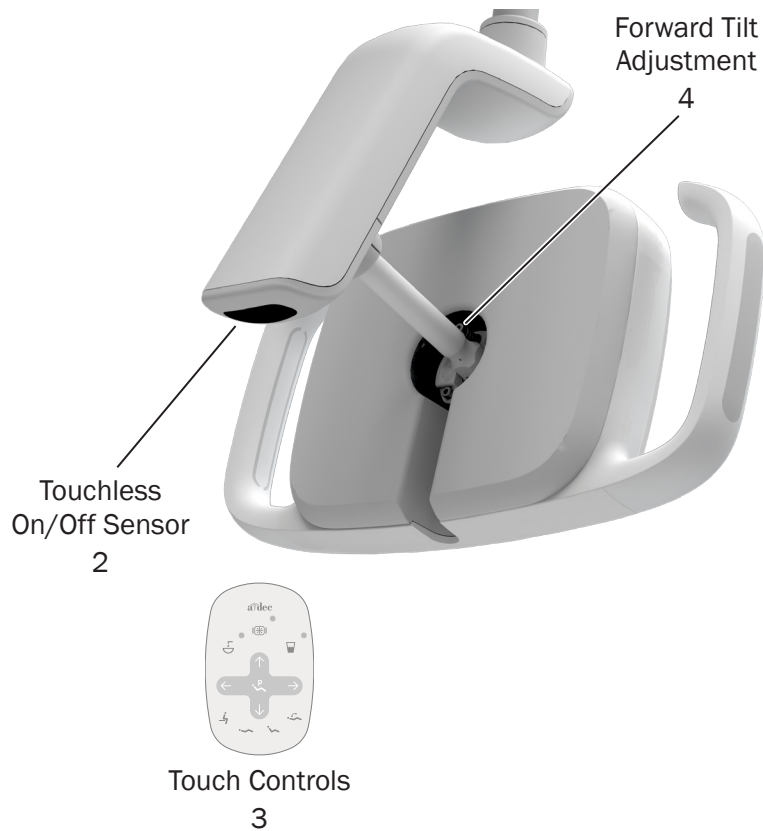

Operate/Adjust	2
Clean/Maintain.....	5
Specifications	8

Operate/Adjust

Touchless On/Off Sensor



Move your hand within 3" (76 mm) below the touchless on/off sensor to turn the light on or off. If the light does not turn on, verify that the delivery system and/or chair power is on.



NOTE Black gloves may impact the sensor's ability to activate the dental light. If you are using white or light-colored gloves and the light still does not turn on, verify that the delivery system or chair power is on.

Operate the Dental Light with Touch Controls*

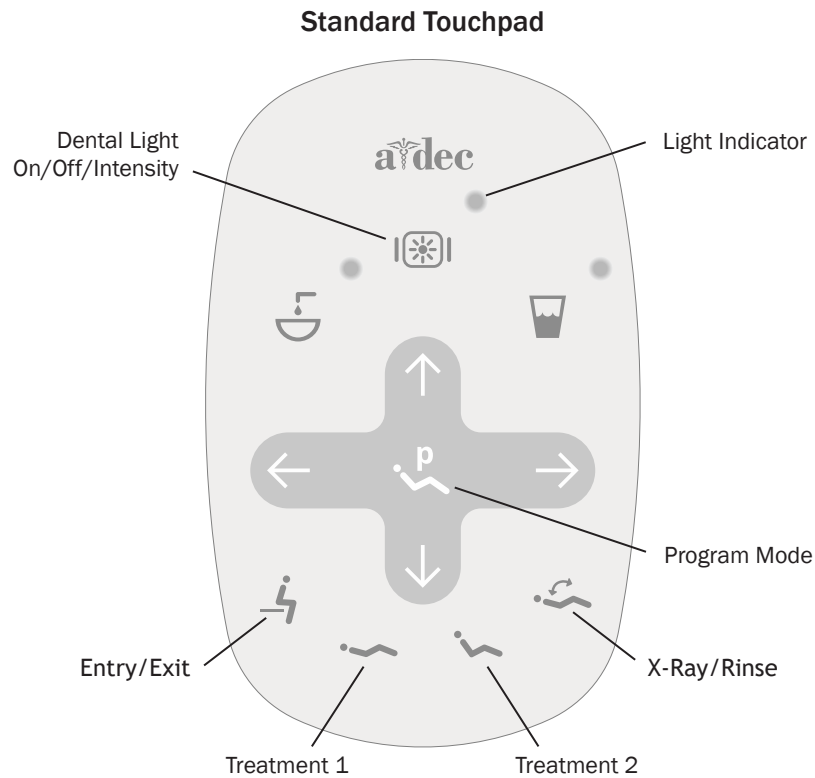

IMPORTANT Standard touchpad is shown. For other touch controls, see the user support materials included with your delivery system.

Turn On/Turn Off the Dental Light and Change the Intensity

From the touchpad:

- Press to turn on the light.
- Repeatedly press and release to toggle between light intensity modes. The light indicator flashes continuously in composite/low mode.
- Press and hold to turn off the light.

Set the Dental Light Auto On/Off Function

When you press or on the touchpad, the dental light automatically turns on once chair motion stops. The light turns off when you press or .

Press and hold and at the same time to disable or enable the auto on/off function.

- **One beep** indicates this function is off.
- **Three beeps** indicate this function is on.

*Note. Touch control symbols and icons are proprietary to A-dec, Inc.

Lighting Features



Composite/Low Mode

The composite/low mode reduces light intensity and premature curing of photo-initiated composites, sealants, and adhesives.

Focal Range

The dental light features a fixed focal range that provides optimum illumination between 16 - 30 inches (400 mm - 750 mm) from the oral cavity.

Range of Motion

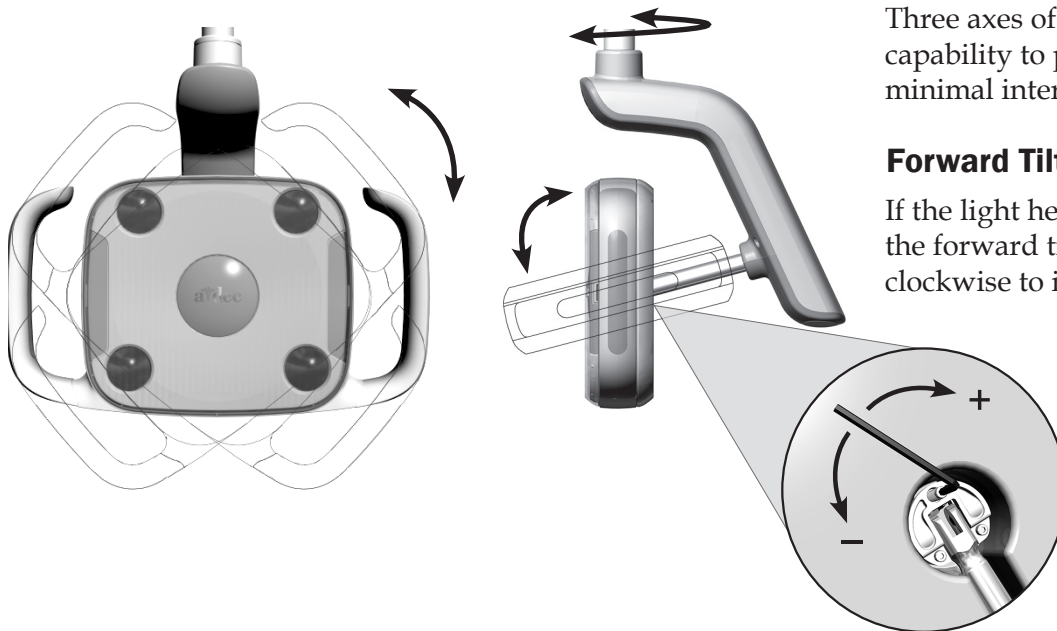

Three axes of rotation provide a wide range of motion. Use this capability to position the light for a clear view of tooth surfaces and minimal interference with other equipment and the dental team.

Forward Tilt Adjustment

If the light head does not hold its tilt position, or is difficult to tilt, adjust the forward tilt tension screw with a 7/64" hex key. Turn the screw clockwise to increase tension or counterclockwise to decrease tension.



NOTE Other tension adjustments require disassembly. Please contact your authorized A-dec dealer if the light requires additional adjustments.

Clean/Maintain

Protect with Barriers

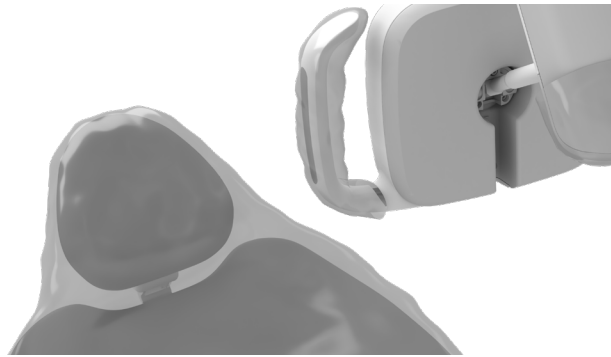

NOTE For proper use and disposal of barriers, see the barrier manufacturer's Instructions for Use.



IMPORTANT For recommendations on cleaning and chemical disinfection of touch and transfer surfaces (where barrier protection is not applicable or when barriers are compromised), please see the *A-dec Equipment Asepsis Guide* (p/n 85.0696.00).

A-dec recommends barrier protection for all applicable touch and transfer surfaces. Touch surfaces are areas that come into contact with hands and become potential cross-contamination points during dental procedures. Transfer surfaces are areas that come into contact with instruments and other inanimate objects.

In the USA, barriers must be produced under the Current Good Manufacturing Practice (CGMP) as specified by the U.S. Food and Drug Administration (USFDA). For regions outside the USA, refer to the medical device regulations specific to your location.

Dental Light Barriers

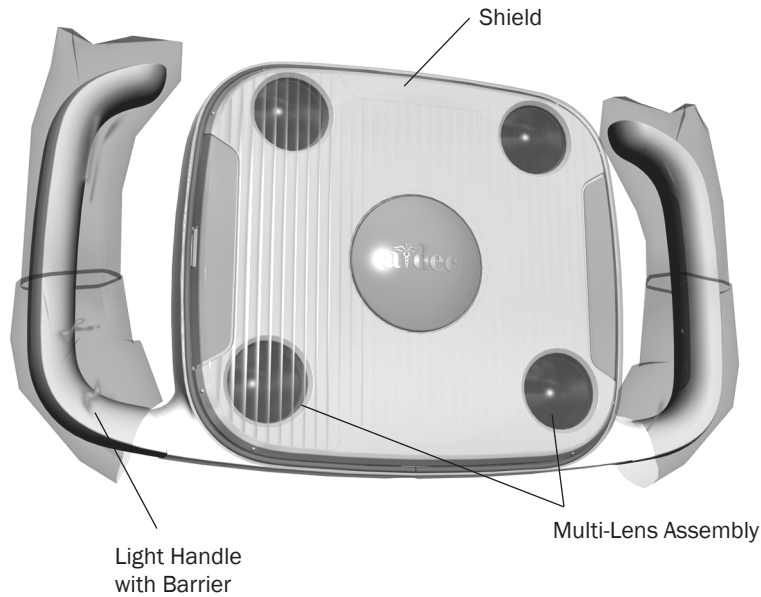

Light Handles

Use barriers on the light handles to prevent cross contamination. The handles are shaped to easily accept the same disposable plastic sleeves designed for the air/water syringe.

Light Shield





CAUTION Do not remove the shield unless absolutely necessary. The shield is fitted with a gasket to prevent dust and debris from entering the lens assembly. If liquid or dirt should bypass the gasket, the shield can be removed for cleaning. Use a flat-blade tool that won't damage the light housing. After removing the shield, do not touch or attempt to clean the multi-lens assembly or you may damage the components.

Barriers help protect and keep the dental light shield clean during procedures. Use only optically-correct barrier film that does not alter the light quality. A-dec recommends the SafeShield™ disposable barrier by Medicom® (see page 7 for ordering information).

If you do not use a barrier, carefully clean the light shield in place using a soft cotton cloth with non-abrasive soap and water.

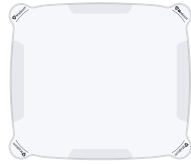
Dental Light Maintenance Parts

Description	Part Number	
Medicom® SafeShield™ Disposable Barrier <i>(package of 10)</i>	9565	
LED Lens Shield and Gasket	90.1343.00	

Contact your authorized A-dec dealer for available dental light maintenance parts.

Specifications



Power and Light Specifications

Power:	15 watts maximum
Focal Range:	16 – 30" (400 – 750 mm)
LED Type:	white HB-LED, 94 CRI
Color Temperature:	white 5000 Kelvin
Light Pattern:	3.8" H x 5.7" W at 27.6" (95 mm H x 145 mm W at 700 mm)
Nominal Light Intensity:	
• high:	25,000 lux (2323 fc)
• composite*/low:	8,000 lux (743 fc)
Heat Output:	51 BTU/hour

* Composite mode is an industry accepted term and is not intended to meet the ISO 9680:2014, 5.2.10 standard.



IMPORTANT For electrical specifications, identification of symbols, and other regulatory requirements, see the *Regulatory Information, Specifications, and Warranty* document (p/n 86.0221.00) available in the Resource Center at www.a-dec.com.



For quick access to this document online, scan, tap, or click this QR code, which points to: a-dec.com/regulatory-guide.



NOTE Specifications are subject to change without notice. Requirements may vary depending on your location. For more information, contact your authorized A-dec dealer.



 **A-dec Headquarters**

2601 Crestview Drive
Newberg, Oregon 97132
United States
Tel: 1.800.547.1883 within USA/CAN
Tel: +1.503.538.7478 outside USA/CAN
www.a-dec.com

A-dec Australia

Unit 8
5-9 Ricketty Street
Mascot, NSW 2020
Australia
Tel: 1.800.225.010 within AUS
Tel: +61.(0).2.8332.4000 outside AUS

A-dec China

A-dec (Hangzhou) Dental Equipment Co., Ltd.
Building 5, No. 528 Shunfeng Road
Tangqi Town, Yuhang District,
Hangzhou, Zhejiang, China 311100
Tel: 400.600.5434 within China
Tel: +86.571.89026088 outside China

A-dec United Kingdom

Austin House
11 Liberty Way
Nuneaton, Warwickshire CV11 6RZ
England
Tel: 0800.ADEC.UK (2332.85) within UK
Tel: +44.(0).24.7635.0901 outside UK



86.0670.00 Rev G
Date of Issue 2024-02-06
Copyright 2024 A-dec, Inc.
All rights reserved.

IFUnewcov4