

aidec® A-dec Stationary Simulator

INSTRUCTIONS FOR USE

Daily Setup

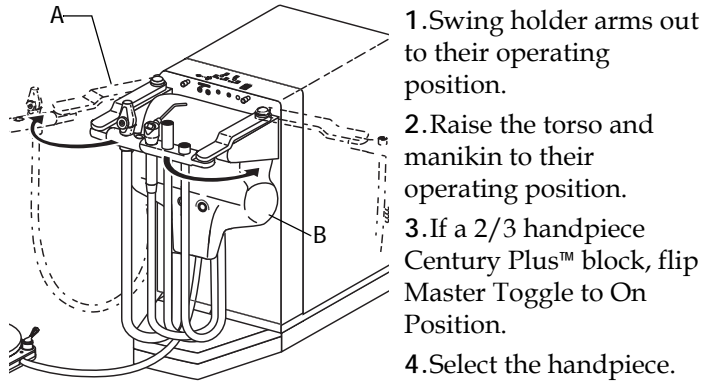

(A) Holder Arm; (B) Torso

Handpiece Selection and Off/On Positioning

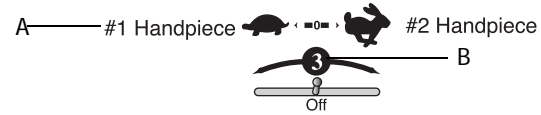

(A) 2-Handpiece Simulator Block Handpiece Selection; (B) Off Position

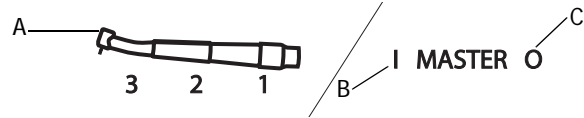

(A) 2/3-Handpiece Century Plus Block Handpiece Selection; (B) On Position; (C) Off Position

Delivery System, Syringe, HVE and Handpiece

Adjustments (2-Handpiece Simulator Block)

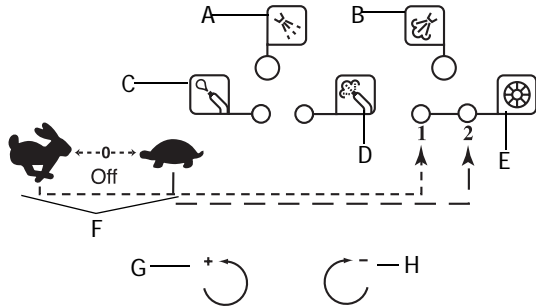

(A) Coolant Water; (B) Coolant Air; (C) Syringe Water; (D) Syringe Air; (E) Drive Air; (F) Handpiece Selector Toggle; (G) To Increase Flow; (H) To Decrease Flow

Adjustments (2/3-Handpiece Century Plus Simulator Block)

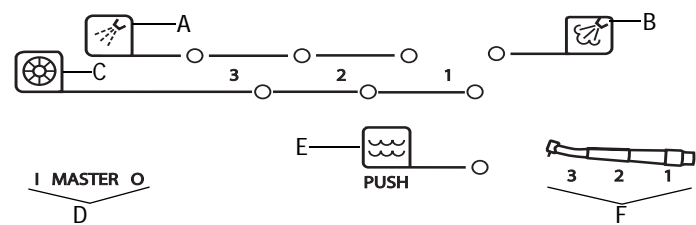

(A) Coolant Water; (B) Coolant Air; (C) Drive Air; (D) On/Off Toggle; (E) Handpiece Flush; (F) Handpiece Selector Toggle

Syringe Operation

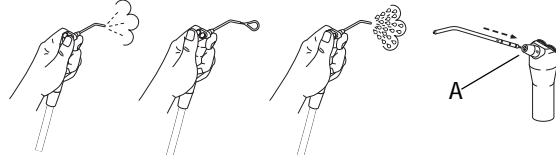

(A) Push in Syringe Tip Until You Feel Three Clicks



WARNING To prevent syringe tip ejection, use only A-dec syringe tips. Be sure to insert the tip fully.

Air Vacuum Generator (AVG)

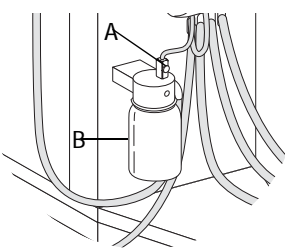

(A) Manikin Drain Knob; (B) Collection Jar

- Activate the manikin drain while using the AVG handpiece
- Empty collection jar as necessary.

Foot Control/Handpiece Activation

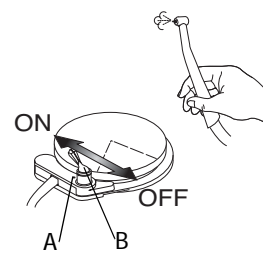

(A) Blue Dot; (B) Foot Control Coolant Water Toggle

1. Use the handpiece selector toggle to select handpiece.
2. Lift the handpiece from its holder.
3. Fully depress the foot control disc. The handpiece activates when you depress the foot control.
4. To turn on water, flip toggle to blue dot.

Central Vacuum

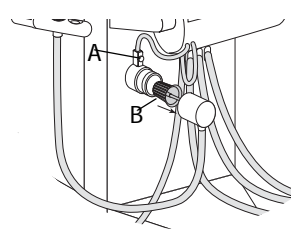

(A) Manikin Drain Knob; (B) HVE Screen

- Turn the knob to activate the manikin drain.
- Clean the HVE screen as necessary.

Torso and Carriage

Raising and Lowering Torso

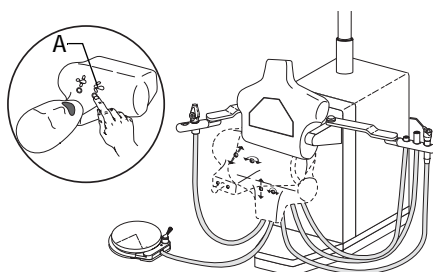

(A) Right Button Raises/Lowers Torso and Manikin

Raising and Lowering Carriage

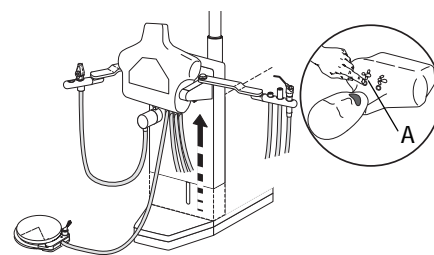

(A) Left Button Raises/Lowers Carriage

Instructions for Use

Headrest/Backrest (Optional)

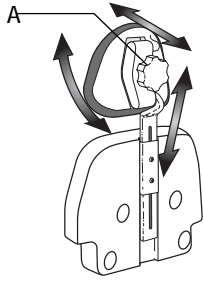

• Loosen knob to reposition headrest. Tighten knob to secure.

(A) Headrest Adjustment Knob

Storage

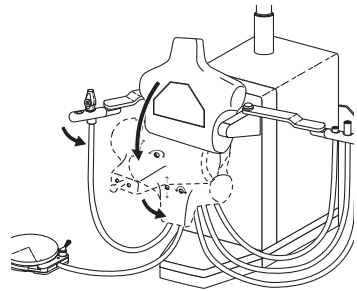

1. Lower torso and manikin to storage position.
2. Swing holder arms into their storage position.
3. Turn the unit off. If a 2-handpiece simulator block, move handpiece selector to 0. If a 2/3-handpiece Century Plus block, flip Master Toggle to Off position.

Dental Light

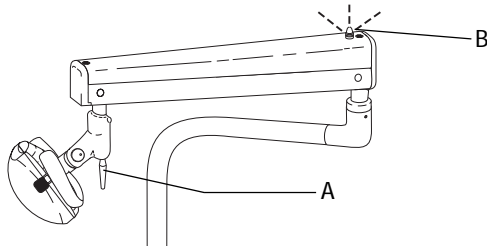

(A) On/Off Switch; (B) Call Light (Optional)

Self-Contained Water (Optional)

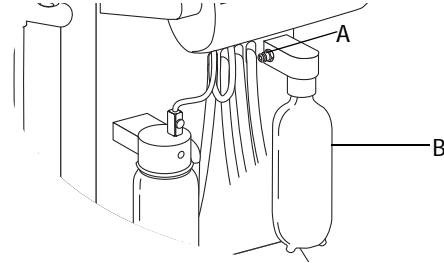

(A) Quick Disconnect; (B) Self-Contained Water

Left-to-Right Conversion

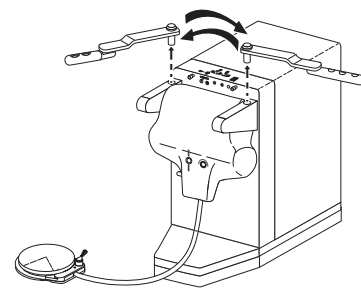

1. Lift holder arm assemblies from arm mounts.
2. Rotate holders.
3. Insert the holder arm assemblies into the arm mounts.

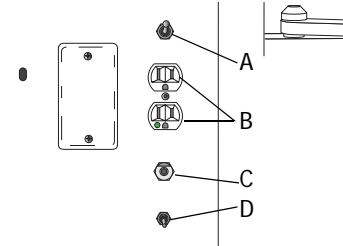

(A) Call Light On/Off Switch; (B) Power Outlets (120v Only); (C) Water Quick Disconnect (City Water Only); (D) Air Quick Disconnect

Identification of Symbols

Symbol	Description
	Recognized by Underwriters Laboratories Inc. with respect to electric shock, fire and mechanical hazards only in accordance with UL 60601-1 (2601-1) and under mutual recognition agreement with CAN/CSA C22.2, No. 601.1.
	Classified by Underwriters Laboratories Inc. with respect to electric shock, fire and mechanical hazards only in accordance with UL 60601-1 (2601-1) and under mutual recognition agreement with CAN/CSA C22.2, No. 601.1.
	UL listed to UL 61010A-1, BS EN 61010-2-010 and Canadian (CAN/CSA C22.2, No. 1010.1-92) safety standards.
	Conforms to applicable European Directives (refer to Declaration of Conformity).
	Protective earth (ground).
	Functional earth (ground).
	Attention, consult accompanying documents. No user serviceable parts. Attention, line voltage. Only licensed electrician should remove cover.
	Type B applied part.
	Class II equipment.
	Caution: Metal surfaces can be hot during and following the dry cycle.

Electrical Rating

Type	Specification
Volts:	100/110-120/220-240 VAC
Frequency:	50-60 Hz
Current:	As configured and specified in equipment manual (products labeled 15A or greater require dedicated circuit, identified in distribution panel).

Classification of Equipment (EN-60601-1)

Type/Mode	Classification
Types of shock protection	CLASS I EQUIPMENT: Dental chairs, dental lights, and power supplies CLASS II EQUIPMENT: Chair, wall, and cart-mounted delivery systems
Degree of shock protection	TYPE B APPLIED PART: Delivery systems only
Degree of protection against water ingress	ORDINARY EQUIPMENT: All products
Mode of operation	CONTINUOUS OPERATION: All models except dental chairs CONTINUOUS OPERATION WITH INTERMITTENT LOADING: Dental chairs - 5% duty cycle
Flammable Gasses:	Not suitable for use in the presence of a flammable anesthetic mixture with air, oxygen, or nitrous oxide, where such gasses may accumulate in concentration (closed space).

Environmental Specifications

Temperature/Humidity	Specification
Storage/Transportation Temperature:	-40°C to 70°C (-40°F to 158°F) - Relative humidity: 80% for up to 31°C, decreasing linearly to 50% at 40°C.
Operating Temperature:	10°C to 40°C (50°F to 104°F) - Relative humidity: 80% for up to 31°C, decreasing linearly to 50% at 40°C.
Indoor Use:	Altitude up to 2,000M (6,563 ft.), installation category II, pollution degree 2. (UL 61010A-1 and CAN/CSA C22.2, No. 1010.1-92 only)

© 2007 A-dec® Inc. All Rights Reserved.
2601 Crestview Drive, Newberg, OR 97132, USA - Printed in USA.
A-dec Inc. makes no warranty of any kind with regard to the content in this document, including but not limited to, the implied warranties of merchantability and fitness for a particular purpose.



85.2647.00

85.2647.00 Rev C 2007_07



(PCA 5736)