

Assistant's Instrumentation

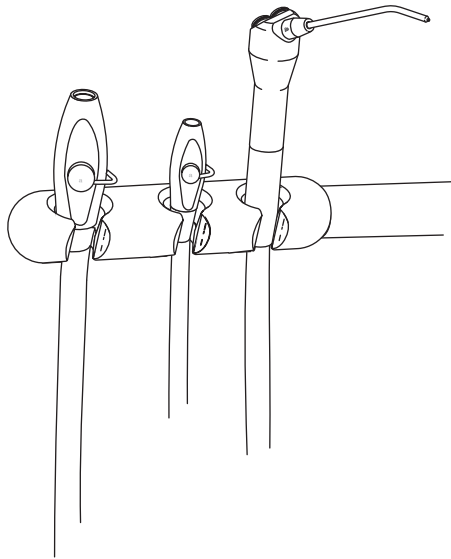

Contents

About Your Assistant's Instrumentation.....	3
Controls.....	3
Instruments.....	4
Autoclavable HVE and Saliva Ejector.....	4
Right-to-Left-Hand Conversion of the Autoclavable HVE and Saliva Ejector.....	4
A-dec HVE/Saliva Ejector Valve Body Assembly Asepsis	4
Cleaning and Disinfection.....	4
HVE Saliva Ejector Tips	6
Disposable Tips.....	6
Solids Collector	6
Solids Collector Asepsis.....	6
Solids Collector for Cascade	6
Solids Collector for Decade.....	7
Adjustments.....	7
Instrument Holder Positioning	7
Pivot Friction.....	7
Twist Friction	7
Touchpad Programming (optional).....	7
Specifications.....	8
A-dec HVE/Saliva Ejector Tip Connections.....	8

Copyright

© 2021 A-dec, Inc. All rights reserved.

A-dec, Inc. makes no warranty of any kind with regard to this material, including, but not limited to, the implied warranties of merchantability and fitness for a particular purpose. A-dec, Inc. shall not be held liable for any errors contained herein or any consequential or other damages concerning the furnishing, performance or use of this material. The information in this document is subject to change without notice. If you find any problems in the documentation, please report them to us in writing. A-dec, Inc. does not warrant that this document is error-free.

No part of this document may be copied, reproduced, altered, or transmitted in any form or by any means, electronic or mechanical, including photocopying, recording, or by any information storage and retrieval system, without prior written permission from A-dec, Inc.

Trademarks and Additional Intellectual Property Rights

A-dec, the A-dec logo, A-dec Inspire, Cascade, Century Plus, Continental, Decade, ICX, ICV, Performer, Preference, Preference Collection, Preference ICC, Radius, and reliablecreativesolutions are trademarks of A-dec, Inc. and are registered in the United States and other countries. A-dec 500, A-dec 400, A-dec 300, A-dec 200, and EasyFlex are also trademarks of A-dec, Inc. None of the trademarks or trade names in this document may be reproduced, copied, or manipulated in any manner without the express, written approval of the trademark owner.

Certain touchpad symbols and icons are proprietary to A-dec, Inc. Any use of these symbols or icons, in whole or in part, without the express written consent of A-dec, Inc., is strictly prohibited.

Regulatory Information and Warranty

For required regulatory information and the A-dec warranty, see the *Regulatory Information, Specifications, and Warranty* document (p/n 86.0221.00) available in the Resource Center at www.a-dec.com.

Product Service

Product service is available through your local authorized A-dec dealer. To locate an authorized dealer, or for additional service information, visit www.a-dec.com or contact A-dec at 1.800.547.1883 in the USA and Canada or 1.503.538.7478 worldwide.

Product Models and Versions Covered in This Document

Model	Version	Description
Cascade/ Decade	A	Assistant's Instrumentation

About Your Assistant's Instrumentation

Assistant's instrumentation typically includes A-dec's Autoclavable Syringe, Autoclavable HVE, and Autoclavable Saliva Ejector as standard equipment. On some units and carts, optional instruments may include an additional HVE. The Solids Collector is also a part of the Assistant's Instrumentation, but its location varies depending on your system.

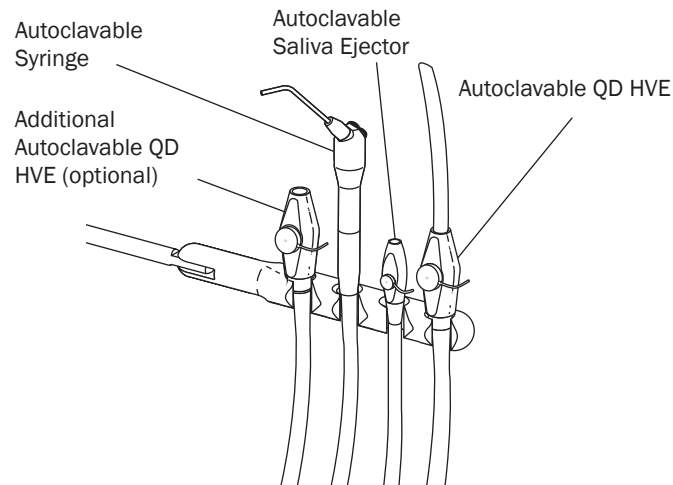

Assistant's Instrumentation
(Shown with optional four position unitized holder
and additional Autoclavable HVE)

Controls

The location of the master on/off toggle for assistant's instrumentation will vary but the function is the same. Moving the toggle to the on position provides air and water to the system. Move the toggle to the OFF position while the unit is unattended to prevent water damage in case of a leak.

Where assistant's instrumentation is installed as part of a delivery system (such as a chair mount system, duo cart, duo Preference unit, or duo wall mount unit), the master on/off toggle is located on the control head.

When the instrumentation is installed on an assistant's cart or assistant's wall mount unit, the master on/off toggle is located on the side of the cart or wall mount unit.

The master on/off toggle for chair-mounted assistant's instrumentation is located on the side of the floor box.

Instruments

Autoclavable HVE and Saliva Ejector

Assistant's instrumentation includes an A-dec Autoclavable HVE and an Autoclavable Saliva Ejector. It may also include a second HVE as an option. The autoclavable HVE and Saliva Ejector are equipped with a quick disconnect to remove the valve body from the tubing for cleaning and autoclaving.

Right-to-Left-Hand Conversion of the Autoclavable HVE and Saliva Ejector

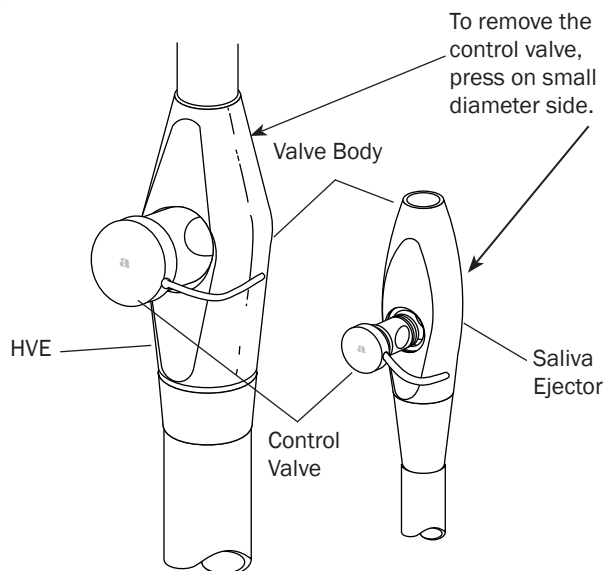

The HVE and Saliva Ejector can be easily converted for opposite-hand operation.

To convert the HVE or Saliva Ejector for opposite-hand use, push the control valve out of the valve body, rotate the control valve 180°, and push it back into place.

A-dec HVE/Saliva Ejector Valve Body Assembly Asepsis



NOTE Vacuum lines should be flushed at the end of each day or more frequently according to your clinic's protocols.

If you use barriers to protect the main body of the HVE and saliva ejector, replace the barriers after each patient. Clean and disinfect these instruments at the end of each day or after each patient if the barriers have been compromised. If you do not use barriers, or if you perform oral surgery, always clean and disinfect these instruments after each patient.

Cleaning and Disinfection



CAUTION Clean the valve body assembly as soon as possible after treating each patient. Do not allow blood and debris to dry on instruments. If you cannot clean it immediately, keep the valve body assembly moist.



NOTE Use an intermediate-level EPA-registered hospital-grade disinfectant containing a tuberculocidal claim with one of the following compositions: high-dilution water-based phenolic formulation or quaternary ammonium compound with less than 25% isopropanol.



NOTE If using a spray solution, spray on a soft, low-lint wipe to apply solution to the valve body assembly.

A-dec HVE/Saliva Ejector Valve Body Assembly Asepsis *(continued)*

To clean and disinfect the HVE and saliva ejector valve body assembly without disconnecting from the vacuum system:

1. Remove the vacuum tip from the HVE or saliva ejector valve body assembly. Discard disposable vacuum tips.
2. Clean the valve body assembly to remove visible soil using a disinfectant wipe or spray solution. Keep the valve body assembly wet according to the manufacturer's recommended contact time. Repeat, if necessary, until the valve body assembly is visibly clean.
3. Disinfect the valve body assembly using a new disinfectant wipe or spray solution. Keep the valve body assembly wet according to the manufacturer's recommended contact time.
4. Allow the valve body assembly to air dry.
5. Operate the HVE and the saliva ejector valves several times to verify that they rotate smoothly.



NOTE A-dec valve body assemblies are heat tolerant for sterilization. Users may sterilize at their discretion.

Routine Maintenance and Sterilization

To routinely maintain and sterilize the HVE and saliva ejector when disconnected from the vacuum system (frequency determined by the user):



CAUTION Clean the valve body assembly as soon as possible after treating each patient. Do not allow blood and debris to dry on instruments. If you cannot clean it immediately, keep the valve body assembly moist.

1. Remove the valve body assembly from the vacuum line by pulling

it away from the tubing at the tailpiece.

2. Disassemble the valve body by pushing the control valve out of the valve body.
3. Clean soiled valve body components using a soft, low-lint wipe.
4. Prepare a warm (32-43°C [90-110°F]) detergent solution (neutral pH enzymatic detergent or alkaline non-enzymatic detergent), according to the manufacturer's recommended instructions.
5. Soak soiled valve body components in the prepared detergent solution for at least one minute.
6. Remove and inspect O-rings. Discard and replace, if damaged.
7. Use a soft, nylon-bristle brush, or equivalent, to scrub the:
 - Exposed surfaces of the valve body components and O-rings, while submerged, for a minimum of 30 seconds or until all visible soil has been removed.
 - Interior lumen of the valve body at least three times (in and out), clearing any visible soil from brush bristles.
8. Rinse the cleaned valve body components under flowing, warm (32-43°C [90-110°F]) potable water for a minimum of 30 seconds.
9. Allow valve body components to air dry.
10. Sterilize the valve body components according to the following:
 - Dynamic air-removal sterilizers: 4 minutes at 132-135°C (270-275°F)
 - Gravity-displacement sterilizers: 30 minutes at 121-123°C (250-254°F)
11. Allow the load to dry for 30 minutes before removing it from the sterilizer. Ensure the valve body components are completely dry before proceeding.
12. Prior to use, lubricate O-rings with A-dec silicone lubricant, and reassemble the valve body assembly.
13. Reinstall the valve body assembly on the tubing tailpiece.
14. Operate the HVE and the saliva ejector control valves several times to verify that they rotate smoothly.

HVE Saliva Ejector Tips



NOTE Select tips that are compatible with your HVE and saliva ejector openings. See “A-dec HVE/Saliva Ejector Tip Connections” on page 8 for specifications.

Disposable Tips



CAUTION Disposable HVE and saliva ejector tips are not sterilizable and should not be reused.



Replace disposable HVE and saliva ejector tips after each use.

Solids Collector

The solids collector prevents solids from entering the central vacuum system.

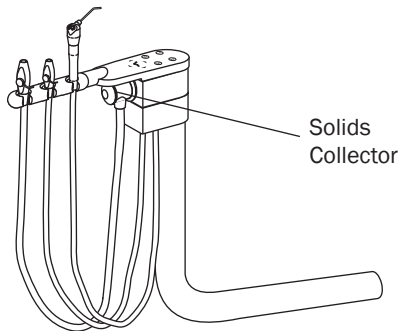

Solids Collector

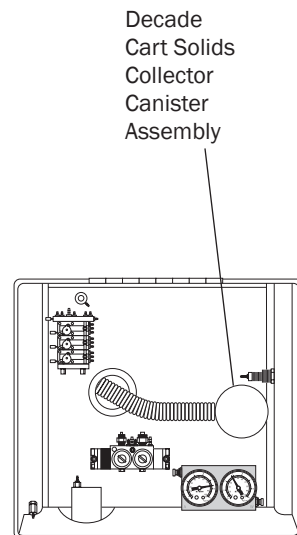

Decade
Cart Solids
Collector
Canister
Assembly

Solids Collector Asepsis

At least once per week, remove and clean (with a mild detergent and water) or discard and replace the solids collector screen for the Cascade products or for the Decade products. This is necessary to ensure proper suction from the central vacuum, and to maintain proper treatment room asepsis.

Solids Collector for Cascade

Turn off vacuum or, if vacuum is on open the HVE control valve to facilitate removal of the solids collector cap.

Remove the solids collector screen and cap from the connector. Pull out on the cap: the screen is attached to the cap.

Remove the screen from the cap. Place your thumb on the large hole and forefinger on the key directly opposite the large hole. Squeeze, then slide the cap out of the screen. Clean the screen. If you have a disposable HVE screen, discard following the manufacturer’s instructions.



CAUTION Do not empty the screen into your cuspidor. Doing so could plug the drain.

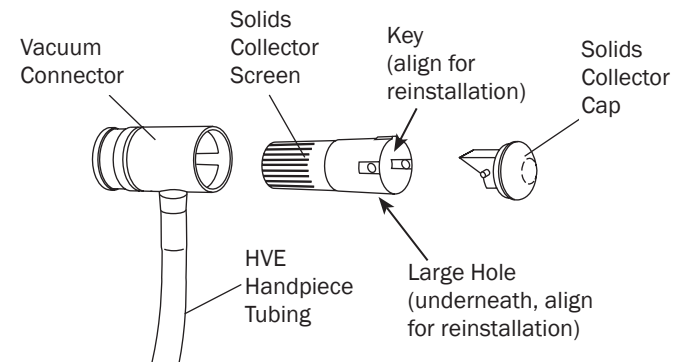

Reinstall the solids collector. Insert the cap back into the screen until the two circular buttons on the cap snap into place. Make sure they are properly aligned with the tongue on the cap directly opposite to the large hole in the screen. Slide the screen and cap into the vacuum connector, making sure the key faces up and the hole faces down.

Solids Collector for Decade

Turn off the vacuum in order to remove the solids collector cap. However, if the vacuum is on, open the HVE to facilitate removal of the solids collector cap. Clean the screen. Do not lubricate the O-rings on the vacuum canister cap.

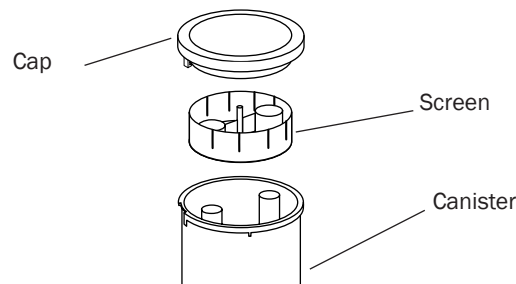

Adjustments

Instrument Holder Positioning

The multi-position style instrument holder is designed to pivot or twist to provide flexibility in positioning the instruments to suit your style of practice. Pivot and twist tension are set at the factory and should not need to be adjusted. If the pivot or twist movement is too tight or too loose, you may want to adjust the friction.

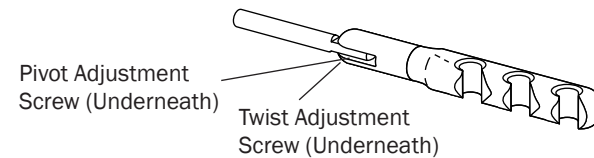

Pivot Friction

To adjust the pivot friction, locate the adjustment setscrew. Use a 5/32" hex key and turn the key clockwise to increase friction which will make the holder pivot less freely. Turn the key counterclockwise to decrease friction and allow the holder to pivot more freely.

Twist Friction

To adjust the twist friction, locate the adjustment setscrew. Use a 3/32" hex key and turn the key clockwise to increase friction which will make the holder twist less freely. Turn the key counterclockwise to decrease friction and allow the holder to twist more freely.

Touchpad Programming (optional)

For touchpad instructions, refer to the instructions for use document or owners guide that came with your dental chair or optional touchpad.

Specifications

Minimum Air, Water, and Vacuum Service Requirements

Air: 2.5 scfm (71 sL/min) at 80 - 125 psi (550 - 860 kPa) minimum

Water: 1.5 gpm (5.7 L/min) at 60±20 psi (410±140 kPa) minimum

Vacuum:

(wet): 9 scfm (255 sL/min) at 10±2 inches of Hg (34±7 kPa) minimum

(dry): 12 scfm (340 sL/min) at 4.5±1 inches of Hg (16±3.5 kPa) minimum

A-dec HVE/Saliva Ejector Tip Connections

Standard 11 mm HVE: 11 mm (0.433") diameter opening
(for standard HVE tips)

Large bore 15 mm HVE: 15 mm (0.591") diameter opening
(for large bore HVE tips)

Standard 6 mm SE: 6 mm (0.236") diameter opening
(for standard SE tips)



A-dec Headquarters

2601 Crestview Drive
Newberg, Oregon 97132
United States
Tel: 1.800.547.1883 within USA/CAN
Tel: +1.503.538.7478 outside USA/CAN
www.a-dec.com

A-dec Australia

Unit 8
5-9 Ricketty Street
Mascot, NSW 2020
Australia
Tel: 1.800.225.010 within AUS
Tel: +61.(0).2.8332.4000 outside AUS

A-dec China

A-dec (Hangzhou) Dental Equipment Co., Ltd.
Building 5, No.528 Shunfeng Road
Tangqi Town, Yuhang District,
Hangzhou, Zhejiang, China 311100
Tel: 400.600.5434 within China
Tel: +86.571.89026088 outside China

A-dec United Kingdom

Austin House
11 Liberty Way
Nuneaton, Warwickshire CV11 6RZ
England
Tel: 0800.ADEC.UK (2332.85) within UK
Tel: +44.(0).24.7635.0901 outside UK



85.2610.00 Rev V
Date of Issue 2021-01-29
Copyright 2021 A-dec, Inc.
All rights reserved.